



*Your Best Choice!*



# Contents

Decking .....	3	
	Super deck ...	12
DIY Tile .....	17	
	Wall Panel ...	21
Louver & Screen ...	26	
	Fencing .....	30
Handrail .....	35	



*Create a leisure space  
isn't a luxury*

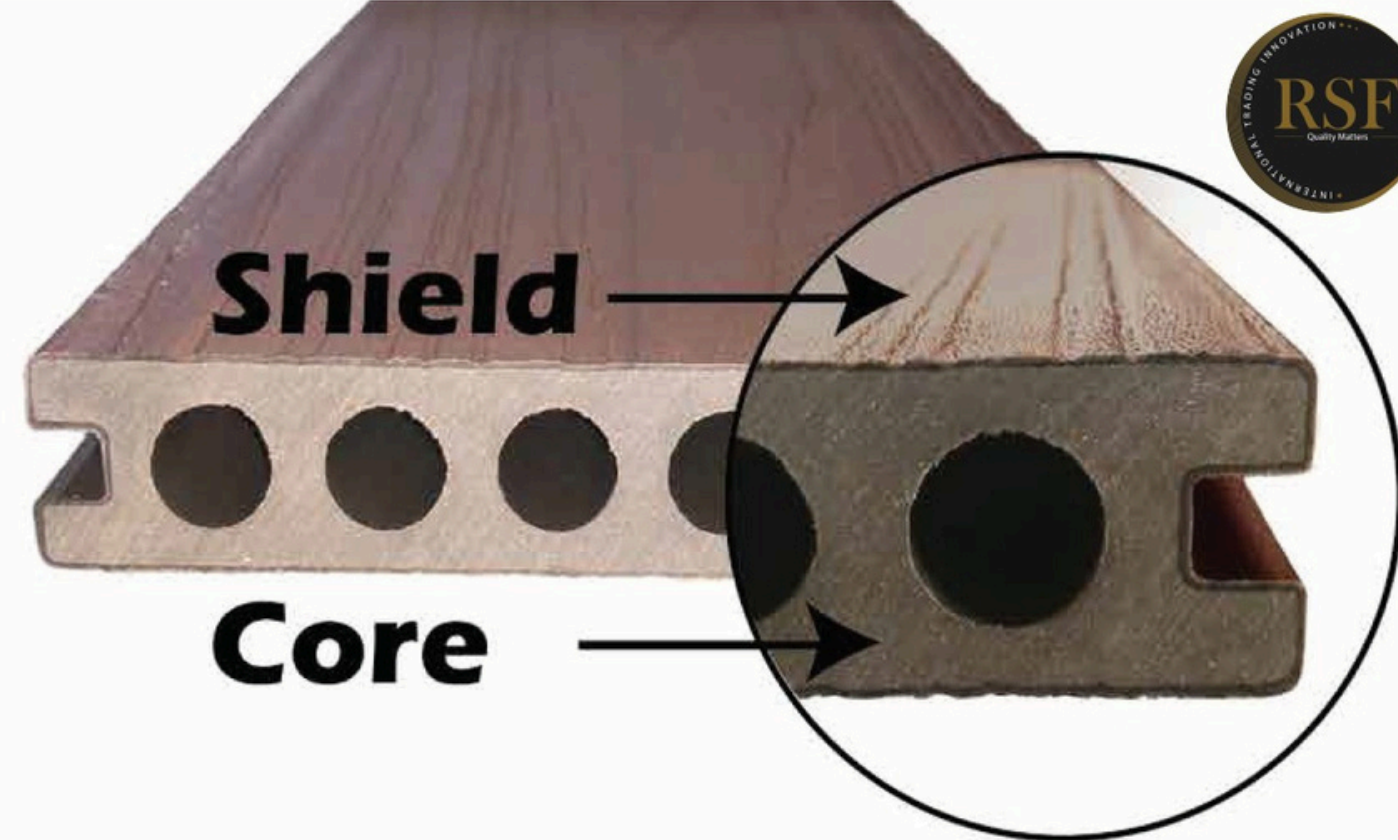

## *New products New technology*

Unlike classical composite decking ( 1st generation ) ,co-extrusion decking ( 2nd generation ) performs much better on physical properties.

It's more waterproof, oil and stain resistant, dimensionally stable and durable.

With the latest technology we can make dual colors on a single board and more colors & finishes are available now.

# Decking Accessories





# FASCIA & TRIM

<p>ZY-CA001</p> <p>10mm 70mm</p>	<p>ZY-CA003</p> <p>100mm 40mm</p>
<p>ZY-CA-004</p> <p>10mm 120mm</p>	<p>ZY-CA-008</p> <p>15mm 140mm</p>
<p>ZY-CA022</p> <p>55mm 55mm</p>	<p>ZY-CA022A</p> <p>55mm 55mm</p>

ZY-CA002

140mm  
22mm

ZY-CA009

140mm  
20mm

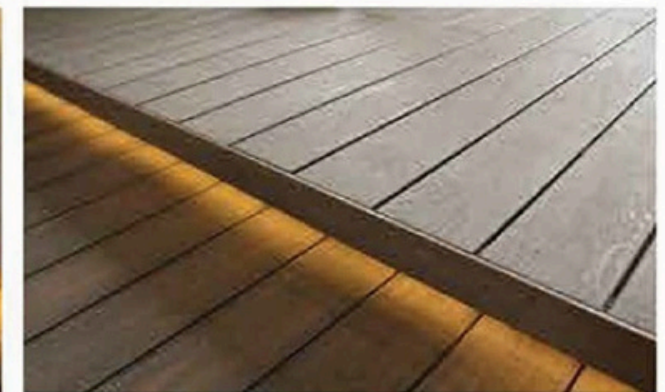
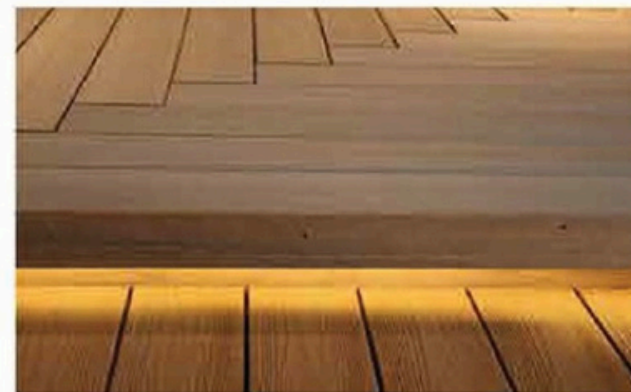

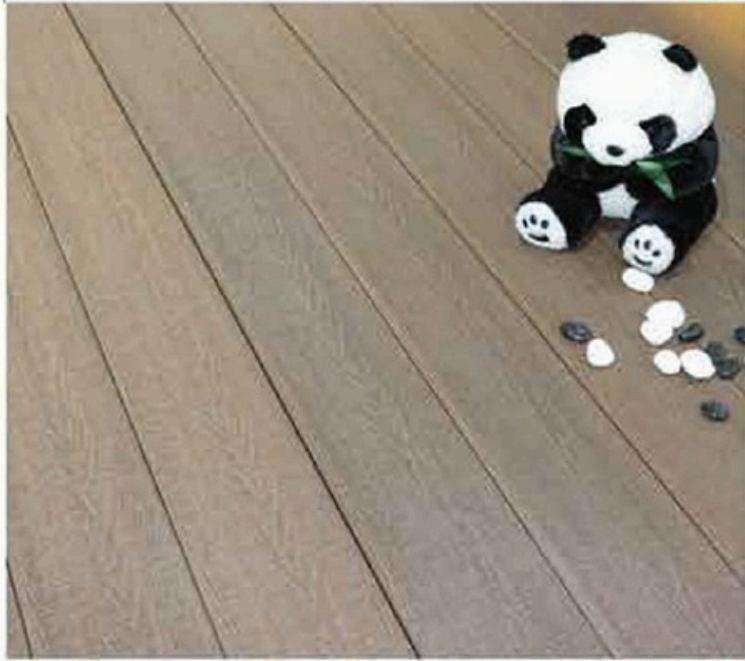

## Color



ANTIQUE LIGHT GREY MAPLE SILVER GREY TEAK RED WOOD WALNUT CHARCOAL

## Typical Wood Grain



CLASSICA

ATTIVO

SUPER

PRATICA



MIRACOLO

MODA

ANTICA

OLA

# SUPER DECK



WEATHER-PROOF



LOW MAINTENANCE



LONG LIFE SPAN



NO PAINTING

## Features of Super Deck

- Premium finish with stylish wood grains
- More matt tone & natural appearance
- Superior scratch resistance
- Stronger impact resistance
- Longer life span





## Color



**ANTIQUE**



**TEAK**



**WALNUT**



**OAK**



**LIGHT GREY**



**CHARCOAL**



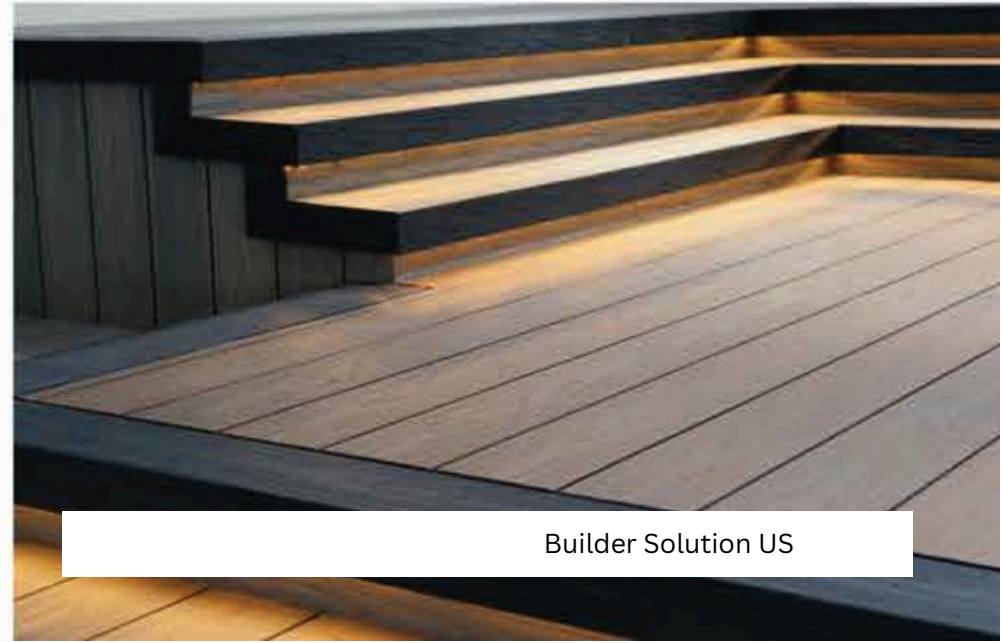
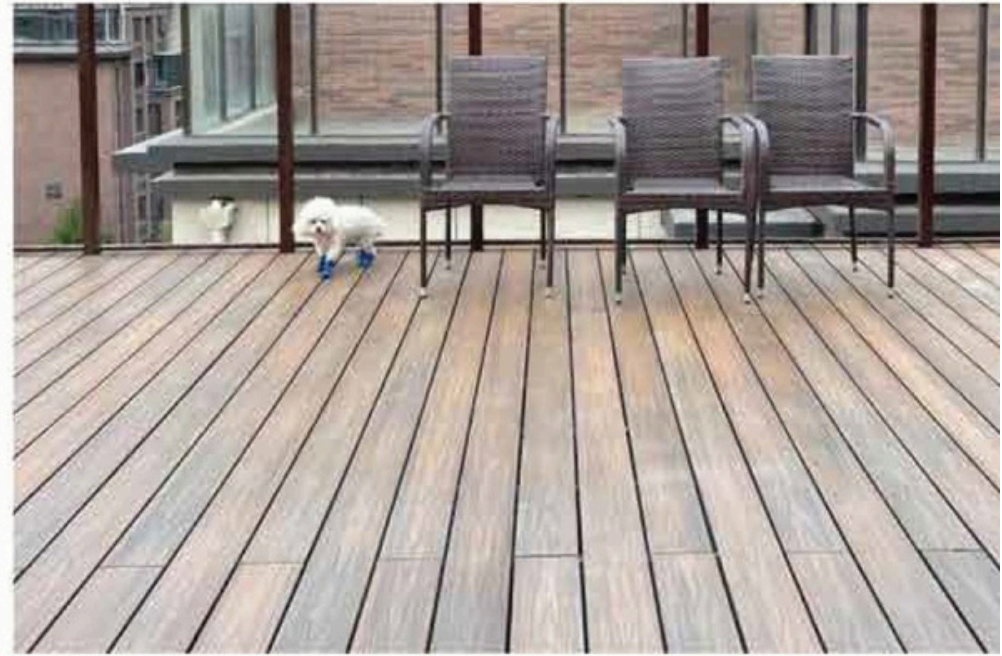

ZY-CT-001



300\*300\*22mm

ZY-CT-004

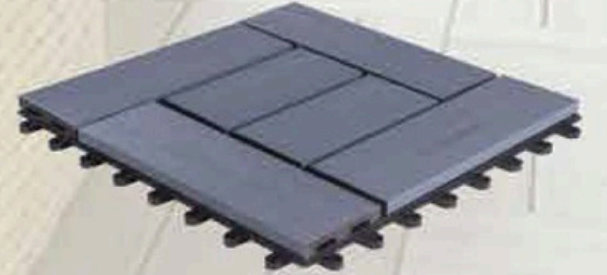
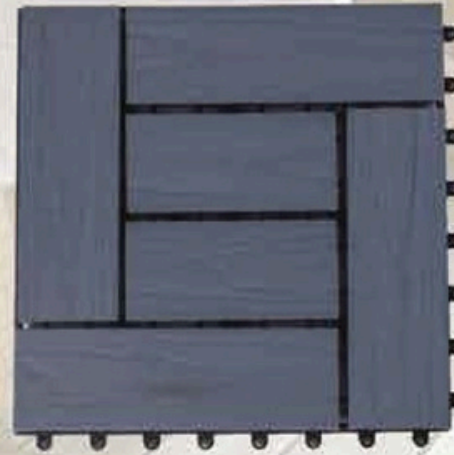

300\*300\*22mm



# DIY TILE

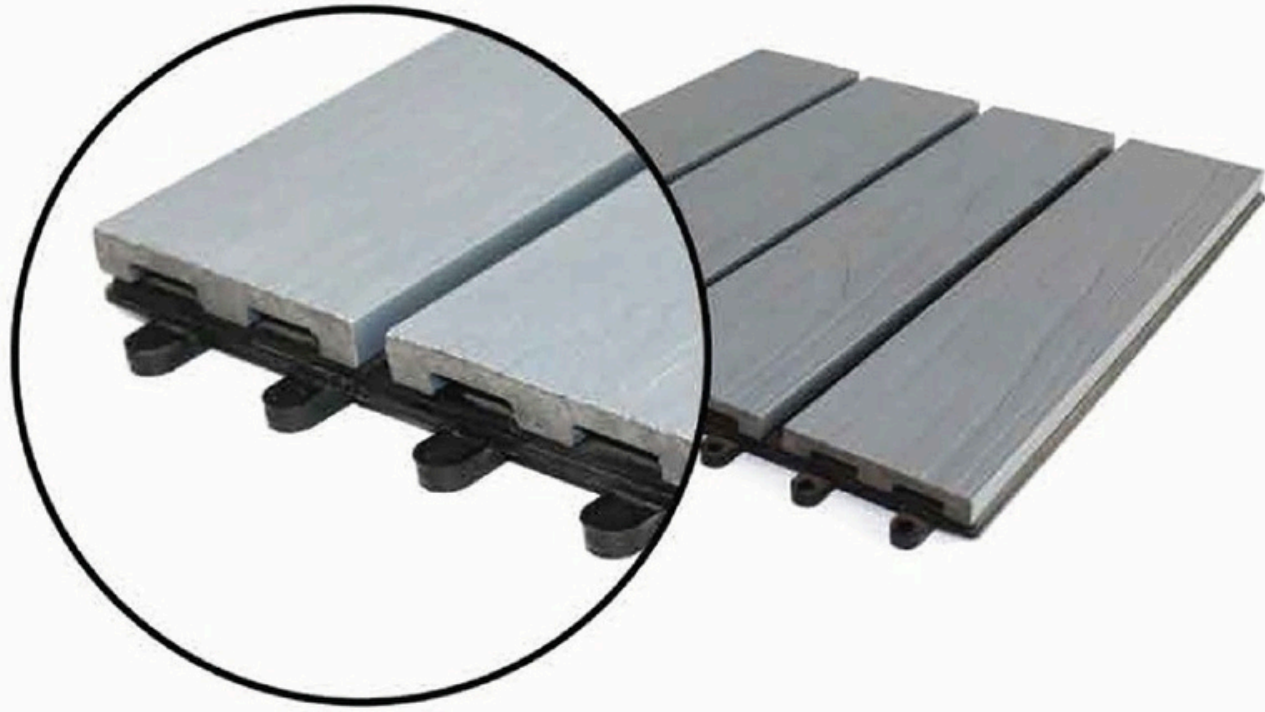

## 2 sides locking base / 4 sides locking base

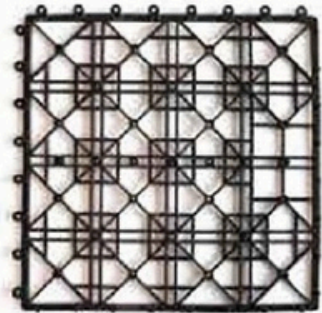

With 2 sides locking base, you can install the deck tiles in a same direction easily.

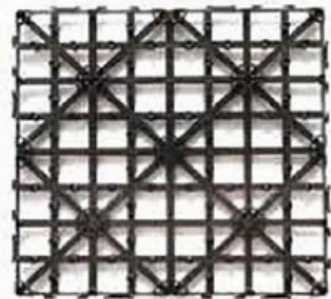

With 4 sides locking base, you can install the deck tiles in either direction freely.

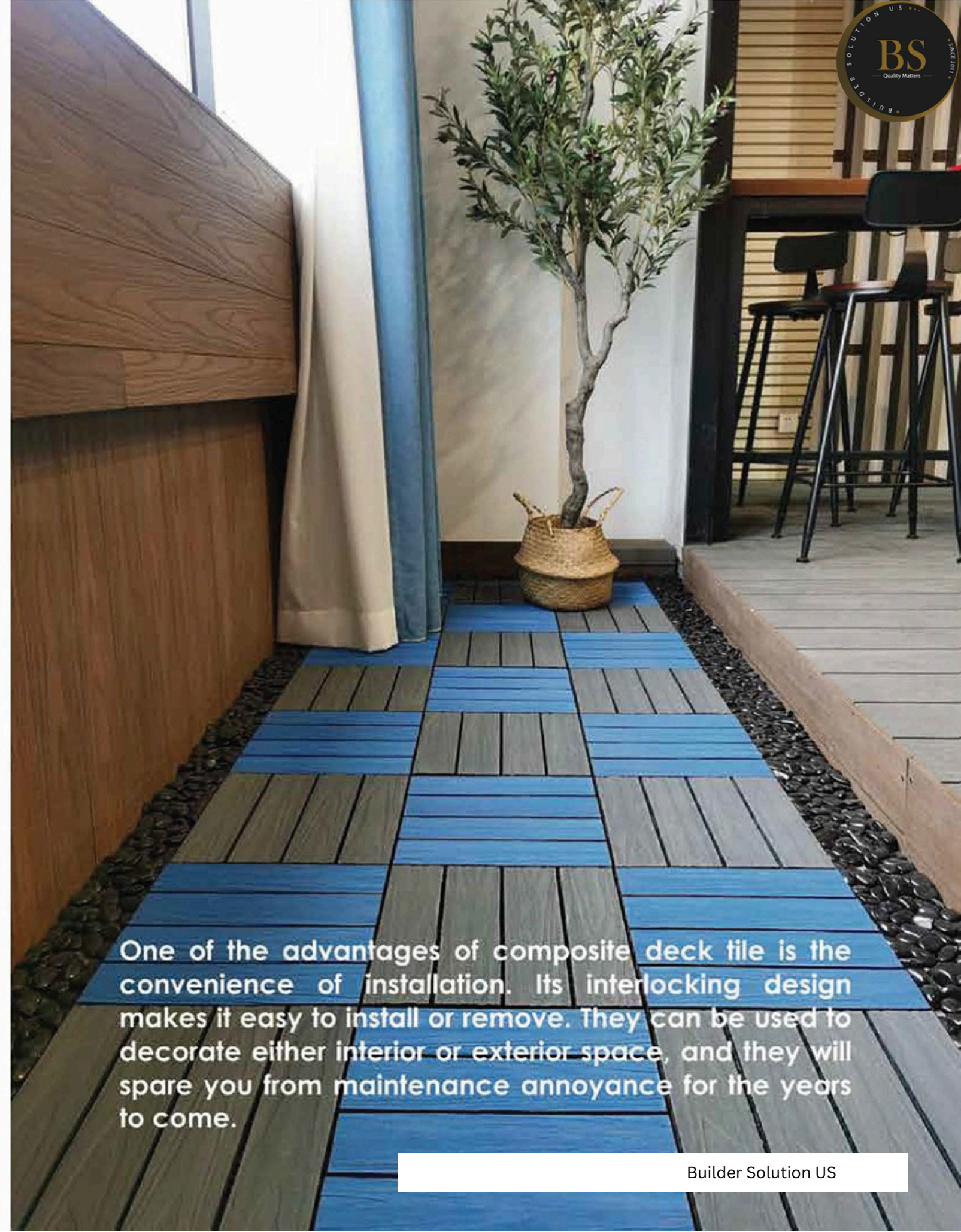

One of the advantages of composite deck tile is the convenience of installation. Its interlocking design makes it easy to install or remove. They can be used to decorate either interior or exterior space, and they will spare you from maintenance annoyance for the years to come.



Wall cladding to a building is dressing to a human being. Get more inspiration from Bammax wall cladding selection, and turn your idea into reality, you will be astonished at the masterpiece you are creating.

# WALL PANEL

Builder Solution US

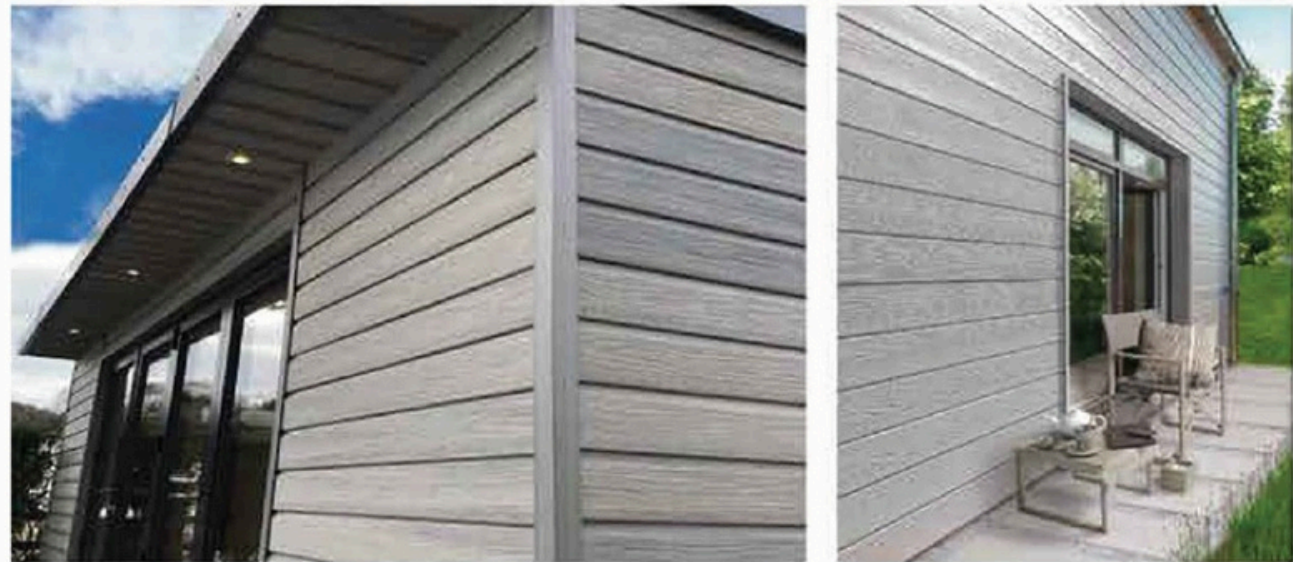
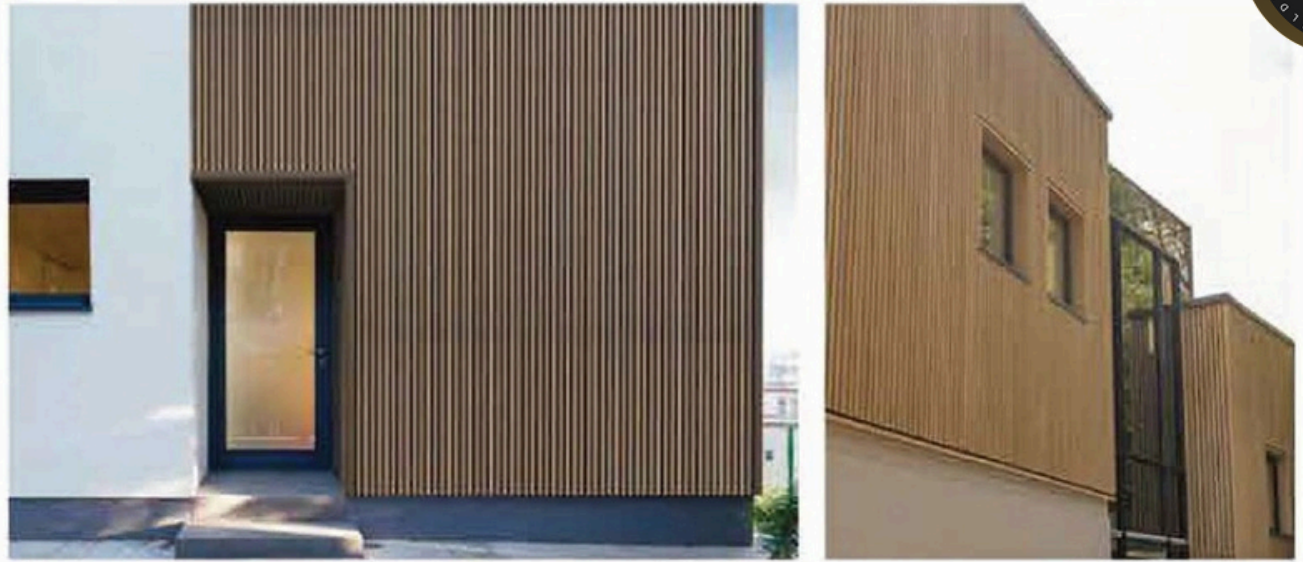

# FASCIA & TRIM

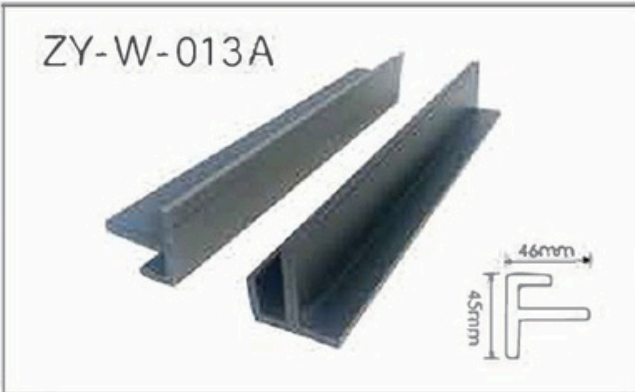





## Wall Panel Accessories





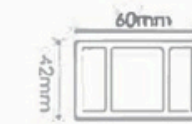

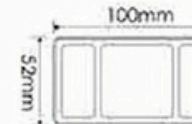
# LOUVER & SCREEN



<p>ZY-CA-005</p>   <p>60mm 42mm</p>	<p>ZY-CA-006</p>   <p>100mm 52mm</p>	<p>ZY-CA-007</p>   <p>120mm 62mm</p>
--	---	---

## Louver&Screen Accessories

  <p>ZY-A-007</p>	  <p>ZY-A-039/040/041</p>	  <p>ZY-A-044/045/046</p>	  <p>ZY-A-047/048/049</p>
---	---	---	---



# FENCING

When you erect fence around your house, you are bringing more to your family. Beauty, privacy, security, they are not demands, they are indeed needs.



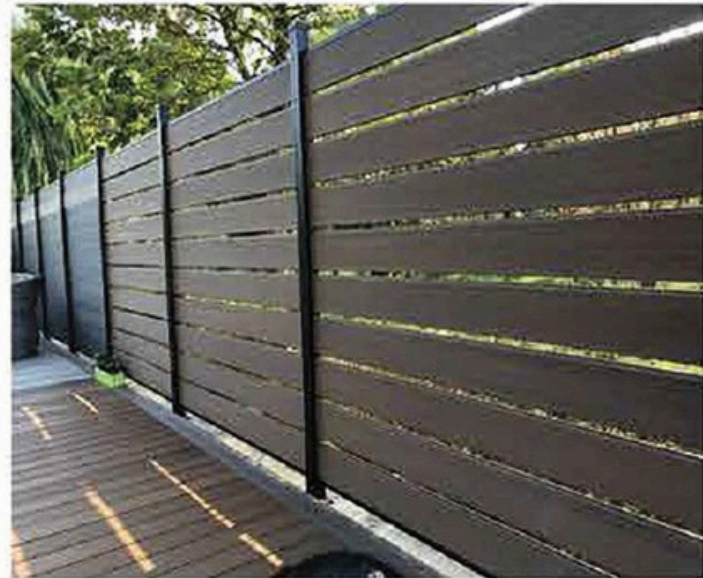

# Fencing System



There is a variety of innovative fencing designs for choice, from sizes to colors, from materials to structures, you name it and we customize it. It's not about a product, it's more about a solution for your home and garden.



# HANDRAIL



ZY-R001



ZY-R002



ZY-R003





# Railing Components



Handrail



Fixed bracket



Base cover



Movable bracket



Post cap with solar light



Post cap with light



Post cap



Inner iron base for post

Post



Expansion screw

\* All the items listed above except for galvanized steel reinforcement, iron base and expansion screws are patented.

