



Sectional Garage Door

01



Garage Door Opener

05



Sectional Industrial Door

07



Industrial Door Motor

10



Aluminum Sectional Overhead Door

11



Garage Door Parts

17

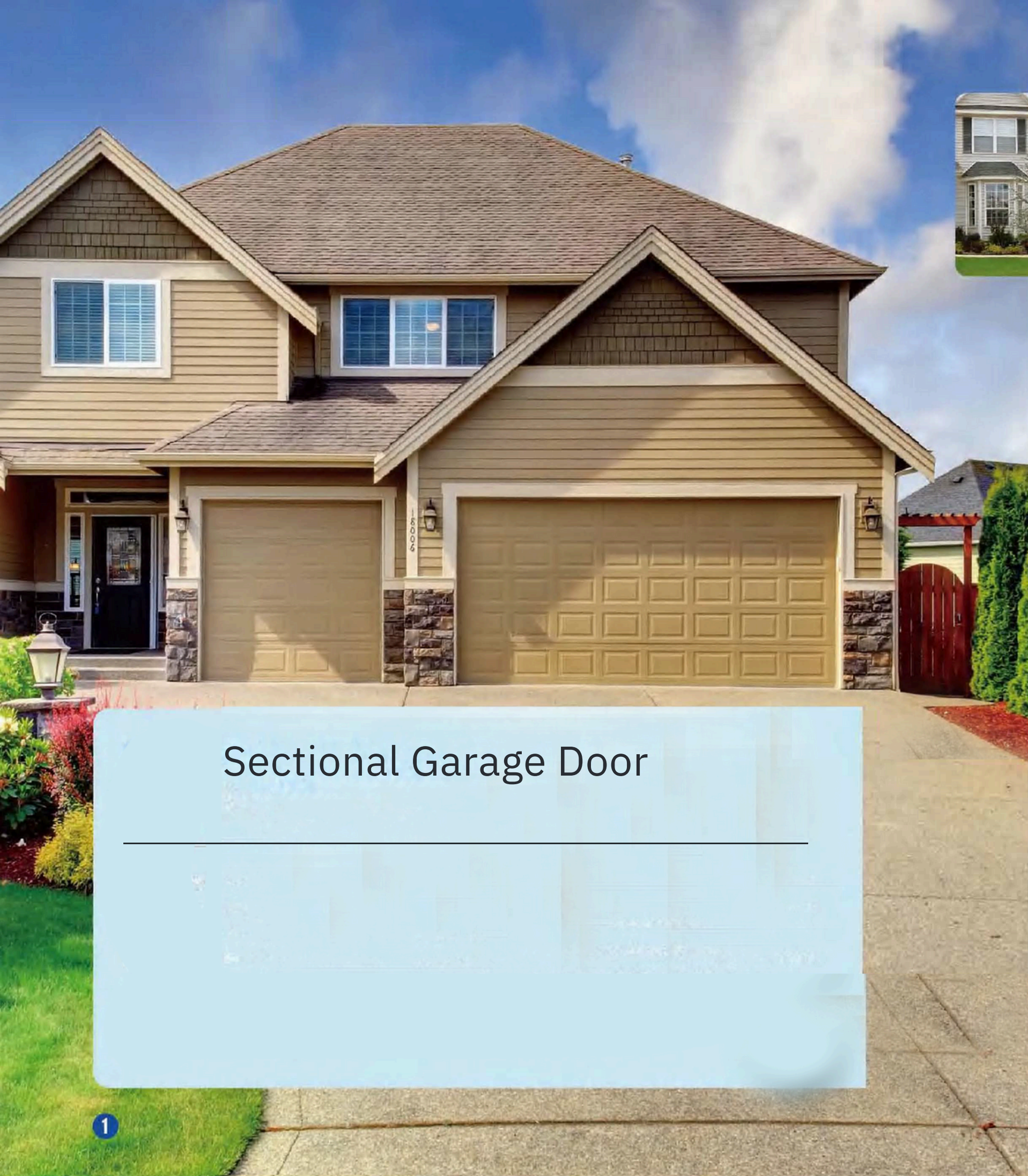

- **Heat Insulation**
The energy-saving polyurethane is high quality heat insulator, non-absorbing and wear-resistant material with R-value 13. 73.
- **Finger Protection**
Safety is important to today's homeowner. As your door closes, the exclusive finger protection system gently pushes fingers away from section joints.
- **Triple-Layer**
Triple-layer door includes the ultimate in thermal properties, plus a layer of steel for a finished interior look and adds durability.
- **High Strength & Resistance Material**
Due to heavy-duty exterior and interior steel, polymeric coating keeps the door nice appearance, low maintenance. durable and reliable.
- **Air Tightness**
The sealing system between door panels and around the door leaf increases the air tightness, prevents heat loss and blocks airflow between sections.
- **Noise Insulation**
The thermal-insulation has sound-proof property. They prevent noise penetrating from the surroundings effectively.

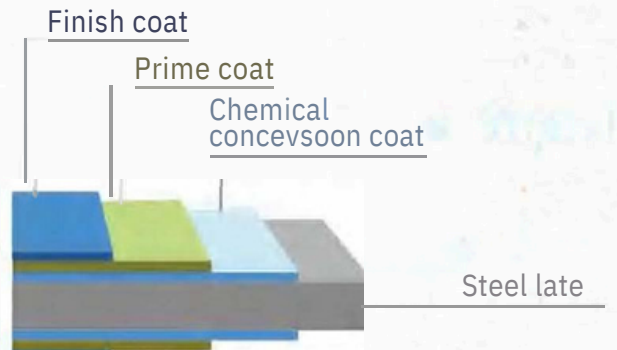

Surface Colors

Normal Color: White RAL9016;

Solid Colors: Brown RAL8014, Light Beige RAL 1015, Anthracite Grey RAL7016, Red RAL3000, Blue RAL5015, Silver RAL9006, Ebony RAL9004



Timber Colors



Mahogany



Gold Oak



Walnut



Maple

Surface Finishes



Woodgrain



Orange Peel



Fold

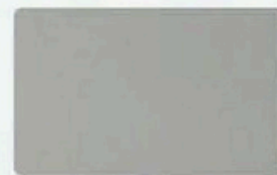

Flush

Panel Characteristics

Panel type: Finger protection panel & non finger protection panel

Material: Galvanized steel with PU foaming

Material thickness: 0.35mm/ 0.45mm/ 0.50mm

Section thickness: 40mm/ 50mm

Panel width: 440mm 550mm

Max available panel length: 12m



Woodgrain with Rectangle



Flush



Woodgrain with 1 Line



Woodgrain with 3 Lines

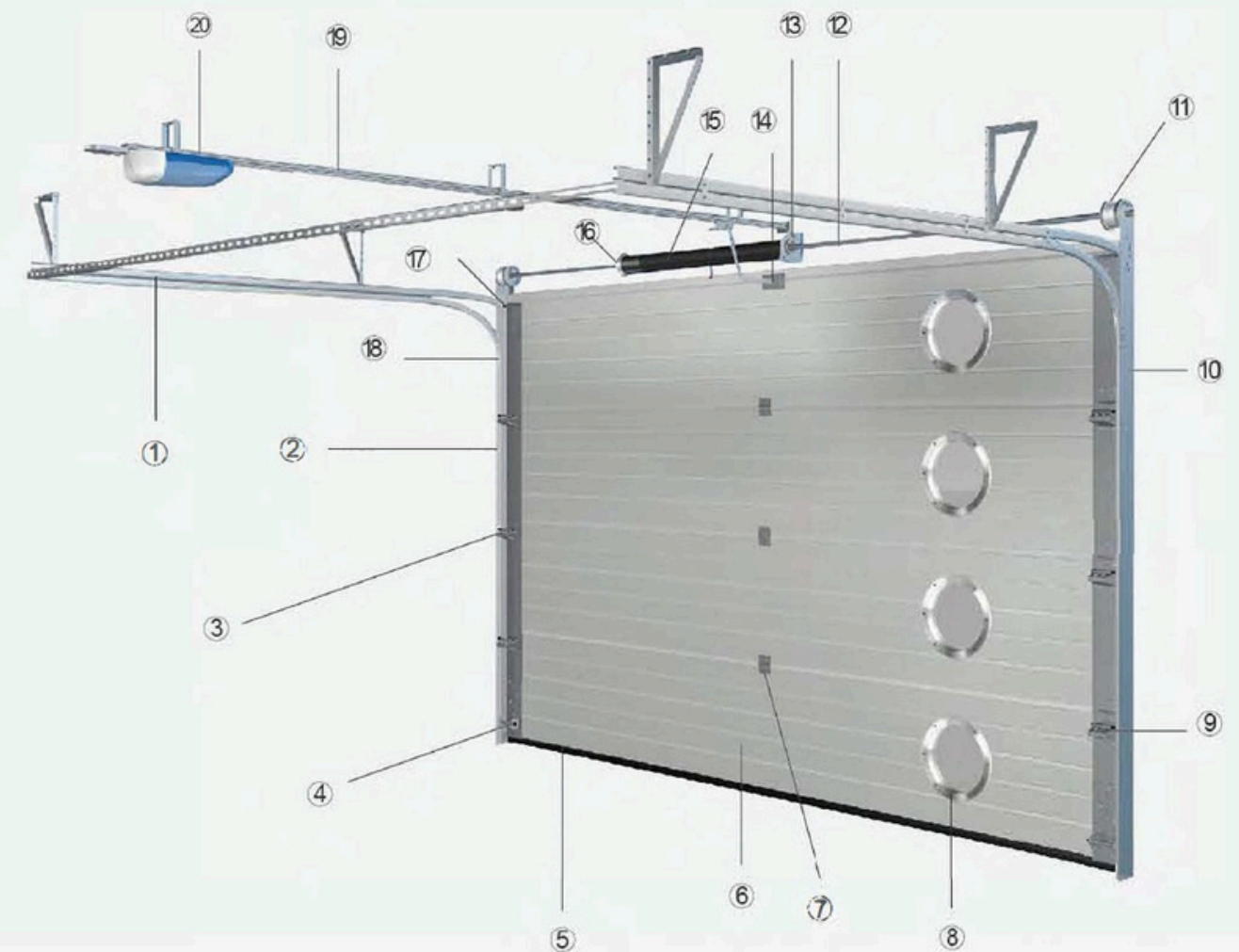

Structure Drawing of Sectional Door

- | | |
|-----------------------------|--------------------------|
| ① Horizontal track | ⑪ Cable drum |
| ② Vertical track | ⑫ Shaft |
| ③ Nylon roller | ⑬ Middle bearing bracket |
| ④ Bottom roller bracket | ⑭ Motor cap |
| ⑤ Aluminum seal with rubber | ⑮ Torsion spring |
| ⑥ Panel | ⑯ Spring cones |
| ⑦ Middle hinge | ⑰ Top roller bracket |
| ⑧ Round window | ⑱ Steel cable |
| ⑨ Side hinge | ⑲ Motor track |
| ⑩ L profile support | ⑳ Motor |

Garage Door Opener



Steel Track



--- Belt Drive Track ---



--- Chain Drive Track ---



--- Aluminum Track ---

Features

	11111	1m111	11m11	111111	1111111
Input Voltage:	AC 220V-240V / 110V-127V, 50-60Hz				
Motor Power:	DC24V	DC24V	DC24V	DC24V	OC24V
Light Power:	10W/24V	10W/24V	10W/24V	10W/24V	10W/24V
Max. Lifting Force:	60KG	80KG	100K	120KG	150KG
Max. Lifting Height:	3.60m	3.60m	3.60m	3.60m	3.60m
Motor Rail:	3.0-4.5m	3.0-4.5m	3.0-4.5m	3.0-4.5m	3.0-4.5m
Rail Type:	Chain/ Belt	Chain/ Belt	Chain/ Belt	Chain/ Belt	Chain/ Belt
Limit Setting:	Electronic	Electronic	Electronic	Electronic	Electronic
Transformer Technology	Overload Protection	Overload Protection	Overload Protection	Overload Protection	Overload Protection
Soft open&close:	Yes	Yes	Yes	Yes	Yes
Radio Frequency:	433.92MHz/ Rolling or Fixed	433.92MHz/ Rolling or Fixed	433.92MHz/ Rolling or Fixed	433.92MHz/ Rolling or Fixed	433.92MHz/ Rolling or Fixed
Working Environment:	-20°C -70°C	-20°C -70°C	-20°C -70°C	-20°C -70°C	-20°C -70°C
Protection Class:	IP20	IP20	IP20	IP20	IP20
Standard Kit:	1 Motor Head, 3.3m Motor Rail(Chain), 2pcs Transmitter, Other Mounting Accessories				

Operation



Using APP by Bluetooth Receiver



Remote Control



Photo Beam Protection



Wireless Pin Code Lock

Sectional Industrial Door



Sectional Industrial Doors are widely applied and it can be a combined one. It is available in all for places of facilities-production, warehouse, sliding systems and also with a range of versions commercial, office and other permises with with windows or with an inserted pedestrian door, heavy traffic intensity, they consist of three main depending on the ceiling and lintel design, and elements: door leaf, track system and torsion also other architectural room peculiarities. They mechanism. The door leaf can be made of finger are able to offer safety, reliability, advanced protection sandwich panels, transparent panels, technology and personalisation.

Sectional Industrial Door

Panel Thickness	Max. Width	Max. Height	Max.SQM
40mm	8000mm	6000mm	40.00
50mm	9000mm	8000mm	50.00



Industrial door with pedestrian door



Industrial door with window

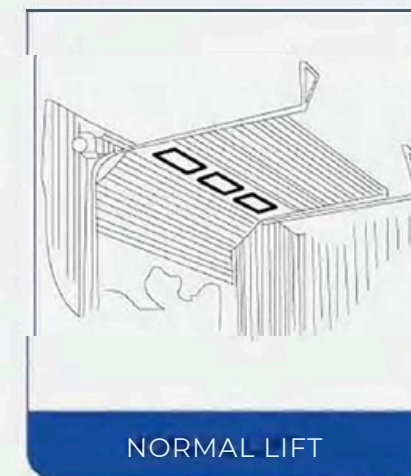

NORMAL LIFT

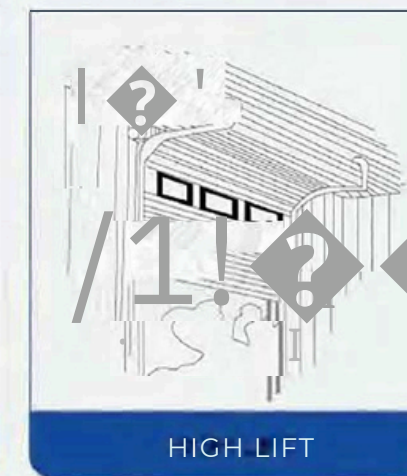

HIGH LIFT



VERTICAL LIFT



NORMAL DECLINING LIFT

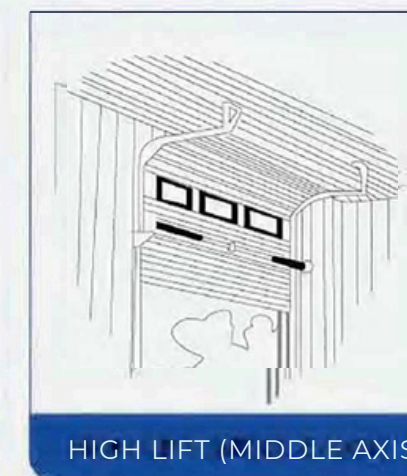

HIGH LIFT (MIDDLE AXIS)

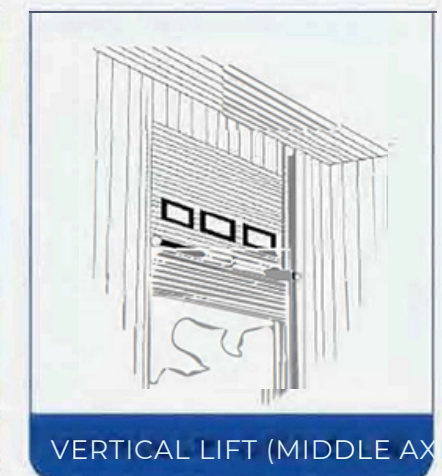

VERTICAL LIFT (MIDDLE AXIS)

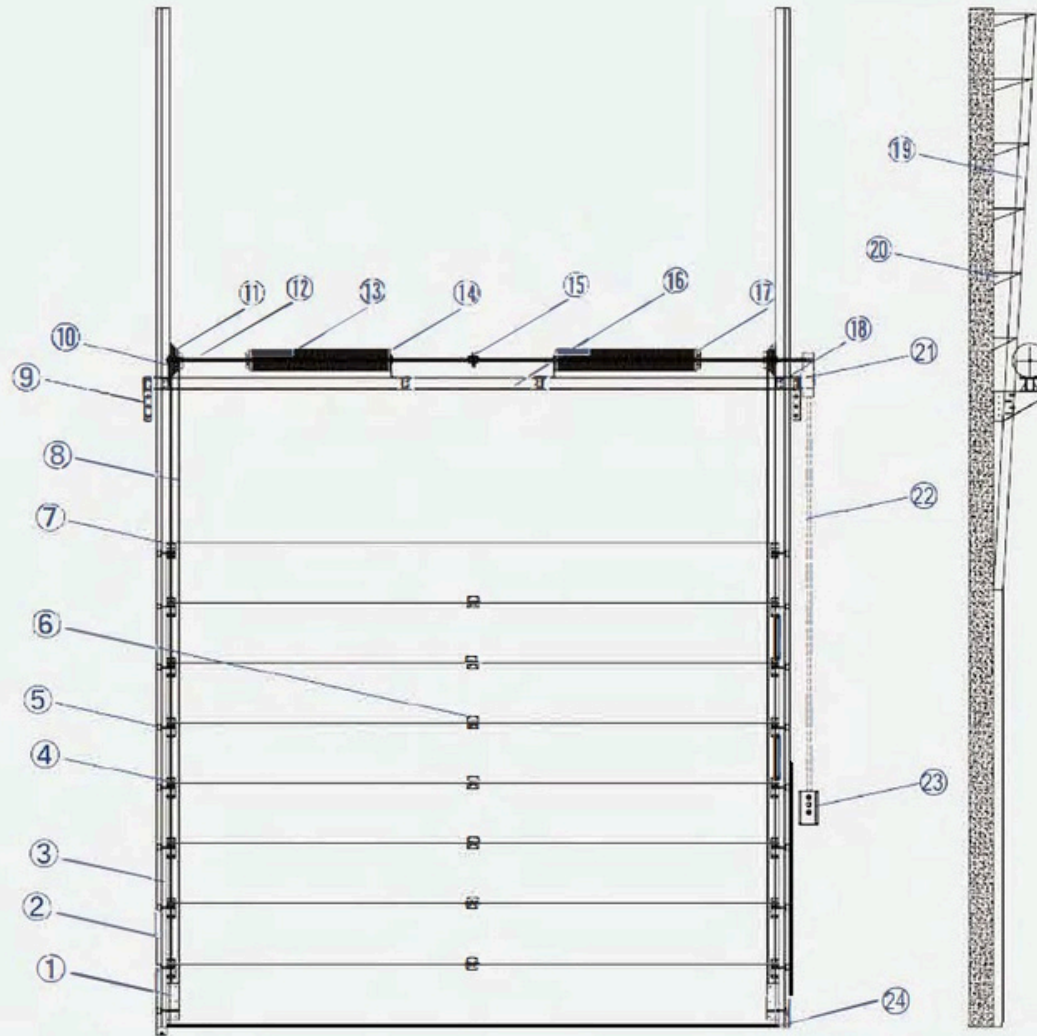

Structure Drawing of Sectional Industrial Door

- | | |
|--|----------------------------------|
| ① Safety Bottom Bracket | ⑬ Torsion Spring |
| ② L Profile Support (for lower vertical Track) | ⑭ Spring Anti-break |
| ③ 2" Lower Vertical Track | ⑮ Shaft Coupler |
| ④ Side Hinge | ⑯ Rectangle Middle Post |
| ⑤ Roller | ⑰ Spring Stationary |
| ⑥ Middle Hinge | ⑱ Holding Bracket |
| ⑦ Top Roller Bracket | ⑲ 2" Upper Vertical Track |
| ⑧ Steel Cable | ⑳ Upper Track Fixing Bracket |
| ⑨ Shaft Support Bracket | ㉑ Shaft-drive Motor |
| ⑩ Side Bearing Bracket | ㉒ Manual Chain Hoist |
| ⑪ VL Cable Drum | ㉓ Push Button |
| ⑫ Solid Shaft | ㉔ Bottom Seal with Airbag Sensor |

Industrial Door Motor

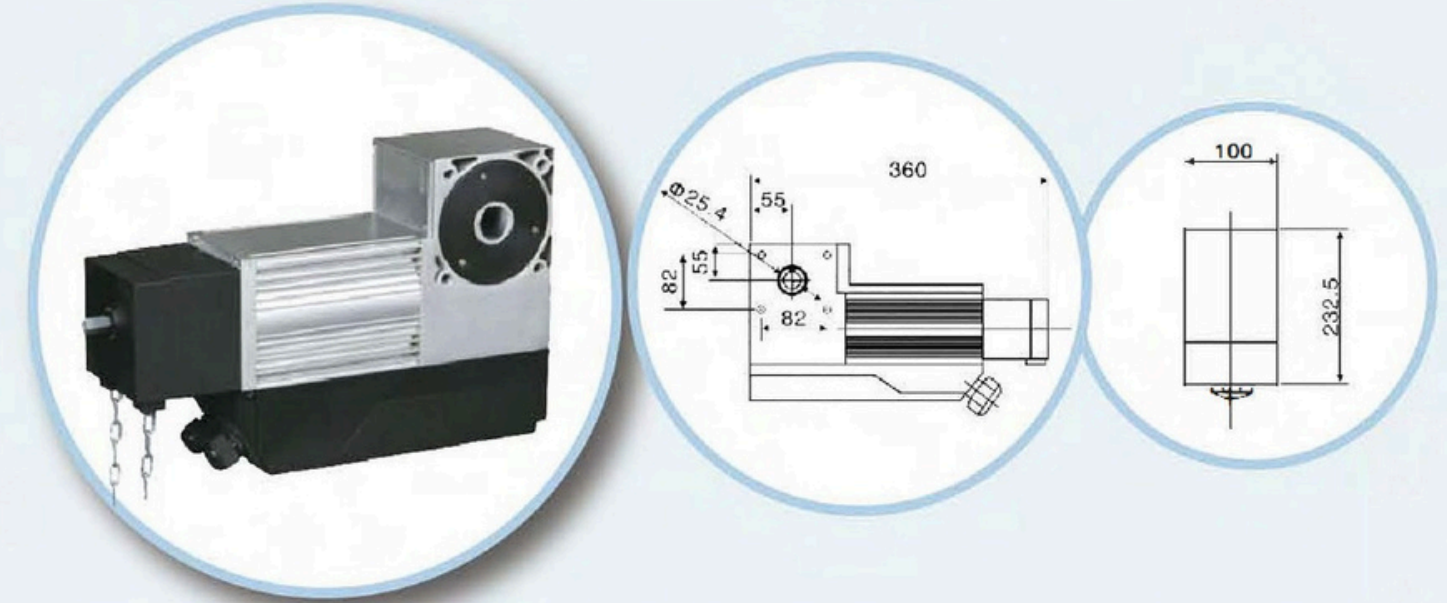

Standard

Optional

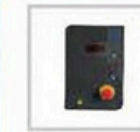

Control box



Installation bracket



Remote control



Alarm lamp



Universal hand chain

Type	MO.SIF30	MO.SIF50
Power Supply	220V/50Hz	380V/50Hz
Output Torque	30N.m	50N.m
Output Rotation Speed	32r/min	32r/min
Motor Rotation Speed	1400r/min	1400r/min
Motor Power	300W	400W
Thermal Protection	120 °C	120 °C
Max.Continuous Working Time	10min	20min
Ambien Temperature	-20°C ~ 45°C (-40°C customization available)	
Barrel Diameter	Φ25.4mm	Φ25.4mm
Flat Key	6mm x 5mm x 70mm	6mm x 5mm x 70mm
Net Weight	12kg	12kg
Dimensions	100 x 233 x 360mm	100 x 233 x 360mm
Max. Rotation	28 cycles	28 cycles
Appliciaon Door SQM	<18m ²	<25m ²

>> Aluminum Sectional Overhead Door



MODEL AF4050

- Durable **40MM finger protection** aluminum frame section
- **Frame:** Anodized or powder coated finishes
- **Frame color customization:** Clear Anodized, powder coating in White, Bronze, Brown, Black etc
- Polycarbonate or tempered **glass/panel options**
- **Great weather barrier** provided by tongue and groove joints
- **Flexible vinyl bottom seal** against dirt, noise and air infiltration&drafts
- **Pedestrian door option** available
- Compatible with Steel Insulated Panel

>> Aluminum Sectional Overhead Door



MODEL AN5081US

- **50MM** Non finger protection aluminum frame section
- **Frame:** Anodized or powder coated finishes
- **Frame color customization:** Clear Anodized, powder coating in White, Bronze, Brown, Black etc
- **Multiple glass panel option:** Polycarbonate, Tempered glass, Aluminum-plastic composite panel, spun silk glass .etc.
- **Customizing glass effects:** Clear, frosted, double glazing, laminated, mirror effect, Silk print image .etc.
- **Superior thermal efficiency** optional with Polyurethane injection inside aluminum frame structure
- **Pedestrian door option** available

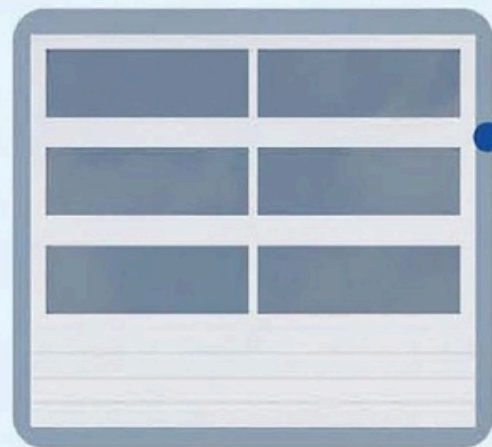

With Insulated Panel

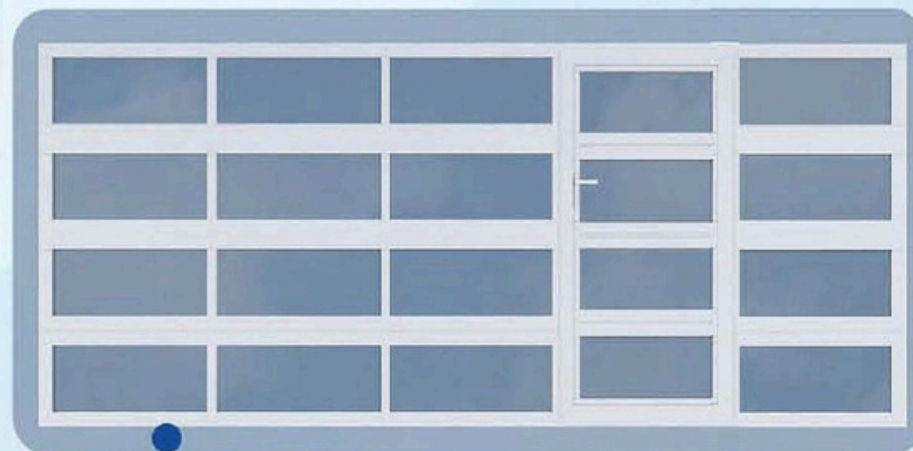

With Pedestrian Door

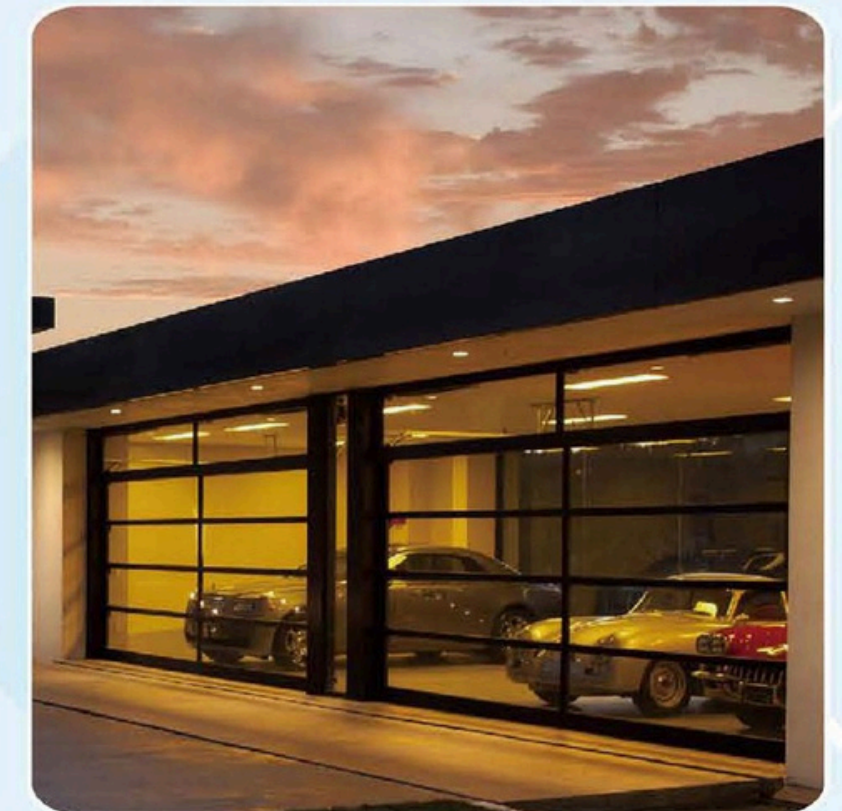
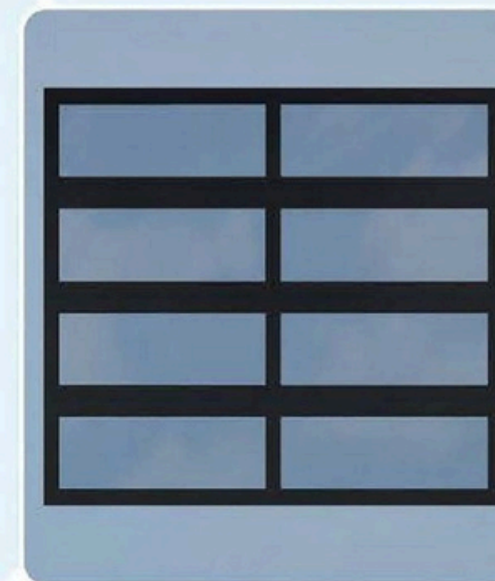

>>> Aluminum Sectional Overhead Door



MODEL AN5005ZA

- **60MM** Non finger protection aluminum frame section
- **Frame structure INVISIBLE** for outside look
- **Frame:** Anodized or powder coated finishes
- **Frame color customization:** Clear Anodized, powder coating in White, Bronze, Brown, Black etc
- **Special glass option:** Mirror effect tempered glass
Aluminum-plastic composite panel, silk printed glass, spun silk glass .etc
- **Superior thermal efficiency** optional with Polyurethane injection inside aluminum frame structure

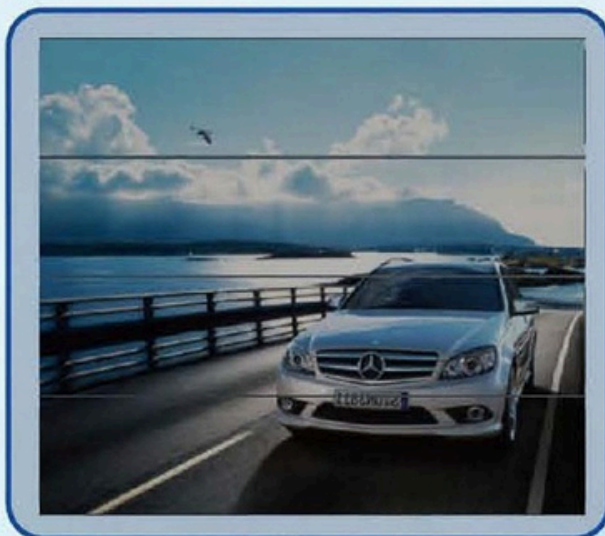

Glass/Panel Options ▶

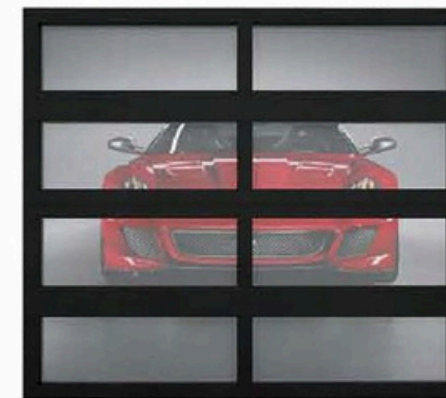

PC Sheet-Clear

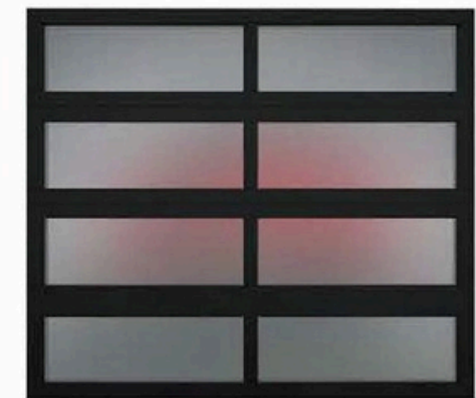

PC Sheet- Frosted



Tempered Glass-Clear



Tempered Glass Frosted

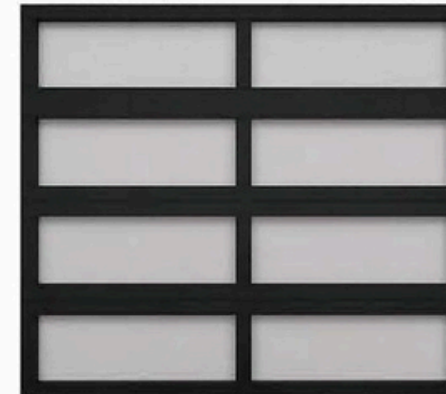

Laminated Glass White



Alu-Composite Panel



Tinted Glass Grey

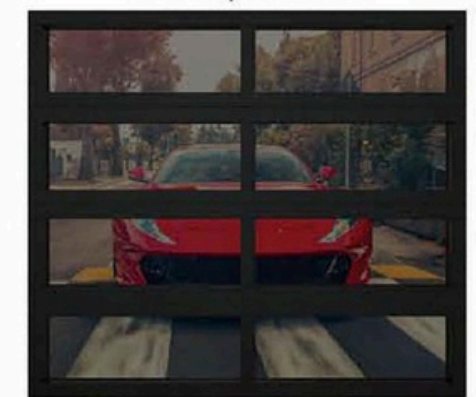

Mirror Glass

>> Garage Door Opener Accessories



Photo Beam

• Transmitter

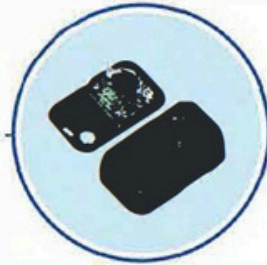

WiFi Receiver

• Safety Airbag Sensor



• Bluetooth Receiver



Pin Code Lock

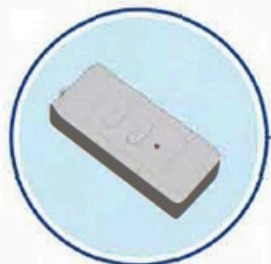

• Wire/Wireless Wall Switch

GSM Remote Control



>> Garage Door Window Options

NO.1	
NO.2	
NO.3	
NO.4	
NO.5	
NO.6	



Door with visible window NO.6



Door with visible Round window
Inner Dia: 330mm/Outer Dia: 360mm

Garage Door Parts

Garage Door Parts



No. 1 Hinge MAS0001.1

Thickness: 1.8mm (14GA)
For 4" stem rollers only



No. 4 Hinge MAS0001.4

Thickness: 1.8mm (14GA)
For 4" stem rollers only



No. 2 Hinge MAS0001.2

Thickness: 1.8mm (14GA)
For 4" stem rollers only



No. 5 Hinge MAS0001.5

Thickness: 1.8mm (14GA)
For 4" stem rollers only



No. 3 Hinge MAS0001.3

Thickness: 1.8mm (14GA)
For 4" stem rollers only

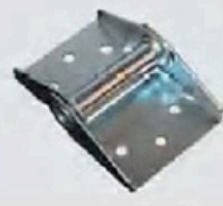

Middle Hinge MAS0002

Thickness: 1.8mm (14GA)
For PU foamed panel only



Side Hinge MAS0101

Thickness: 2.0mm Galvanized steel / Width: 60mm
For 4" stem rollers SF40S / SF40 only



Side Hinge MAS0801

Thickness: 2.5mm / Width 70mm
For 4" stem rollers only



Side Hinge MAS0501

Thickness: 2.5mm / Width: 85mm
For 4" stem rollers, SF40S/SF40 only



Side Hinge MAS1001

Thickness: 2.0mm / Width: 65mm
For 4" stem rollers only



Side Hinge MAS0601

Thickness: 2.0mm / Width 65mm
For 4" stem rollers only



Double Side Hinge MAS0501DB

Thickness: 2.5mm / Width: 130mm
For 7" stem rollers, SF40S / SF40 only

Garage Door Parts



Double Side Hinge Tube MAS0556
 Thickness:2.5mm / Width: 150mm
 For 7" stem rollers only



Side Hinge MAS1201
 Extruded Aluminum / 60mm
 For 4" stem rollers only



Side Hinge MAS1101
 Thickness:2.0mm / 70mm For industrial use
 For 4" stem rollers, SF40S/ SF40 only



Intermedia Hinge MAS0102
 Thickness:2.0mm / 60mm
 For SF40S panel only



Side Hinge MAS0701
 Casting Aluminum / 60mm
 For 4" stem rollers, SF40S / SF40 only



Intermedia Hinge MAS0102.B
 Thickness:2.0mm / 60mm
 For SF40S / SF40 panel only



Intermedia Hinge MAS0502
 Thickness: 2.5mm / 65mm
 For SF40S / SF40 panel only



Intermedia Hinge MAS1002
 Thickness:2.0mm
 Width 65mm



Intermedia Hinge MAS0602
 Thickness:2.5mm
 Width: 65mm



Intermedia Hinge MAS1102
 Thickness:2.0mm Galvanized steel / Width: 90mm
 For SF40S / SF40 panel only



Intermedia Hinge MAS0802
 Thickness:2.0mm
 Width: 65mm



Intermedia Hinge MAS0302
 Casting Aluminum / Thickness:2.5mm
 Width: 60mm

Garage Door Parts



Top Roller Bracket MAS0003
 Thickness:1.5mm
 For 4" stem rollers only



Top Roller Bracket MAS0603
 Thickness:2.5mm
 For 4" stem rollers only



Top Roller Bracket MAS0803
 Thickness:2.5mm
 For 4" stem rollers only



LHR Top Roller Bracket MAS0903
 Thickness:1.8mm
 Length: 220mm / 400mm



Top Roller Bracket MAS0703
 Casting Aluminum
 For 4" stem rollers only



Bottom Bracket MAS0004
 Thickness:2.3mm



Safety Bottom Bracket MAS0804
 Casting Aluminum



Bottom Bracket MAS0604
 Thickness:2.5mm
 Max lifting: 165KG



Safety Bottom Bracket MAS0504A
 Unadjustable, for 2" track only
 Max lifting: 750KG



Bottom Bracket MAS0304
 Casting Aluminum



Safety Bottom Bracket MAS0504B
 Adjustable, For 2" track only
 Max lifting: 750KG

Garage Door Parts

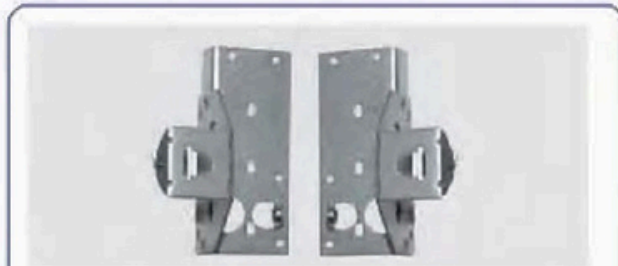

Bottom Bracket MAS0704

Thickness: 2.5mm / 4.0mm
Max lifting: 100KG, For industrial use only



Bearing Bracket MAS0105

Thickness: 2.0mm
Distance: 65mm



Safety Bottom Bracket MAS0904

Adjustable, for 3" track
Max lifting: 750KG



Bearing Bracket MAS0005

Thickness: 2.5mm
Distance: 84mm

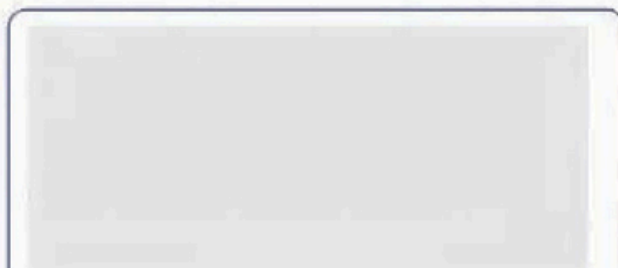

Bearing Bracket MAS0605

Thickness: 2.5mm
Distance: Adjustable



Spring Anti-Break MAS0505

For 1 3/4" and 2" spring only



Bearing Bracket MAS0705

Thickness: 4.0mm
Distance: 110mm, 123mm, 152mm



Spring Anti-Break MAS0305

For 2 5/8" and 3 3/4" spring only



Bearing Bracket MAS0805

Thickness: 4.0mm
Distance: 152mm



Support Bracket MAS0356

Thickness: 4.0mm
Extend distance to 152mm for 6" spring



Side Bearing Bracket MAS0606

Thickness: 2.5mm
Distance: 65mm/84mm

Garage Door Parts



Flanged Bearing MAS0036

1" bore
Outside Diameter: 2"



Flanged Nylon Bushing MAS0136

1" bore
Outside Diameter: 2"



Jamb Bracket MAS0527

Thickness: 2.5mm
Length: A76mm / B93mm / C104mm / D115mm



Nylon Roller MAS0007

Diameter: 2", for 2" track only
Stem: 4" / 7 ball, 11ball



Steel Roller MAS0507

Diameter: 2", for 2" track only
Stem: 4" / 10 ball



Nylon Roller MAS0707

Diameter: 2", for 2" track only
Stem: 7" / 11ball



Steel Roller MAS0607

Diameter: 2", for 2" track only
Stem: 7" / 10 ball



Nylon Roller MAS0907

Diameter: 2", for 2" track only
Stem: 7" / Precision 6200ZZ



Steel Roller MAS0608

Diameter: 3", for 3" track only
Stem: 7" / 10 ball



Roller Protect MAS0134

Plastic
For 2" roller



Nylon Roller MAS0807

Diameter: 2", for 2" track only
Stem: 4" / Precision 6200ZZ

Garage Door Parts



8'NL Cable Drum MAS0013.NL8
 Max Lifting Height: 8'
 Max Cable diameter: 1/8"



10'NL Cable Drum MAS0013.NL10
 O.D.: 83mm / Max Lifting Height: 10'
 Max Cable diameter: 1/8"



12'NL Cable Drum MAS0013.NL12
 Max lifting Height: 12'
 Max Cable diameter: 5/32"



18'NL Cable Drum MAS0013.NL18
 Max Lifting Height: 18'
 Max Cable diameter: 3/16"



12'NL Cable Drum MAS0013.NL12B
 3 Nuts / Max lifting Height: 12'
 Max Cable diameter: 5/32"



18'NL Cable Drum MAS0013.NL18B
 3 Nuts / Max Lifting Height: 18'
 Max Cable diameter: 3/16"



32'NL Cable Drum MAS0013.NL32
 Max Lifting Height: 32'
 Max Cable diameter: 1/4"



11'VL Cable Drum MAS0315.VL11B
 3 Nuts / Max Lifting Height: 11'
 Max Cable diameter: 3/16"



32'NL Cable Drum MAS0013.NL32B
 3 Nuts / Max Lifting Height: 32'
 Max Cable diameter: 1/4"



18'VL Cable Drum MAS0315.VL18
 Max Lifting Height: 18'
 Max Cable diameter: 3/16"



11'VL Cable Drum MAS0315.VL11
 Max Lifting Height: 11'
 Max Cable diameter: 3/16"



28'VL Cable Drum MAS0315.VL28B
 3 Nuts / Max Lifting Height: 28'
 Max Cable diameter: 1/4"

Garage Door Parts



4-54HL Cable Drum MAS0314
 Max Lifting Height: 54" vertical + 120"
 Max Cable diameter: 1/8"



164HL Cable Drum MAS0314
 Max Lifting Height: 164" vertical + 229"
 Max Cable diameter: 1/4"



5-54HL Cable Drum MAS0314
 Max Lifting Height: 54" vertical + 180"
 Max Cable diameter: 3/16"



Spring Fittings 1 3/4U MAS0017
 Universal thread
 Max wire diameter: 295



120HL Cable Drum MAS0314
 Max Lifting Height: 120" vertical + 144"
 Max Cable diameter: 3/16"



Spring Fittings 2"U MAS0017.2U
 Universal thread
 Max wire diameter: 306.5



Spring Fittings 2 5/8U MAS0317
 Universal thread
 Max wire diameter: 331



Spring Fittings 6"S MAS0317
 Single thread for LH / RH wound springs
 Max wire diameter: 437.5



Spring Fittings 3 3/4U MAS0317
 Universal thread
 Max wire diameter: 406.2



Cable Sleeve MAS0060
 Aluminum 2.38mm/3.18mm/4.0mm/5.0mm



Spring Fittings 3 3/4S MAS0317
 Single thread for LH / RH wound springs
 Max wire diameter: 406



Cable Sleeve MAS0160
 Aluminum 2.38mm/3.18mm/4.0mm/5.0mm

Garage Door Parts



3" Pulley MAS0018.3

Bored for 3/8" bolt
Max Cable diameter: 3/16"



S-hook with Split MAS0042/0043

Thickness: 1.5mm
For Extension Spring only



3" Pulley MAS0018.3Y

Bored for 3/8" bolt / Yellow plating
Max Cable diameter: 3/16"



U - fork MAS0041.3

Work with 3" pulley
3/8" Bolt



4" Pulley MAS0018.4

Bored for 3/8" bolt
Max Cable diameter: 1/4"



Extension Spring Bracket MAS0061

Thickness: 2.0mm
For Extension Spring only



Flag Bracket MAS0126

Thickness: 2.0mm
Length: 460mm

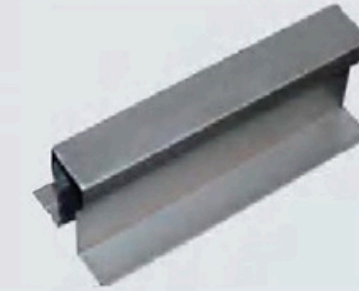

Exterior Reinforce Bar MAS0131

Thickness: 1.5mm
For Industrial door use



Corner Angle MAS0046

Thickness: 2.5mm
Length: 550mm

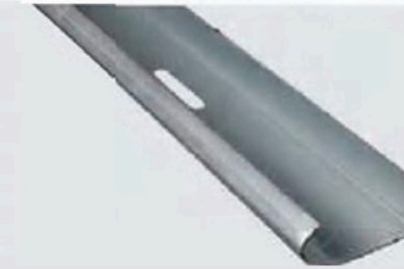

2" Track MAS0010.2

Steel thickness: 1.5mm / 1.8mm / 2.0mm
Curve option: R12 / R15

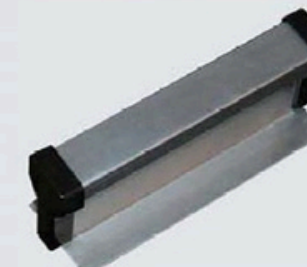

Exterior Reinforce Bar MAS0031

Thickness: 1.5mm
For residential door use

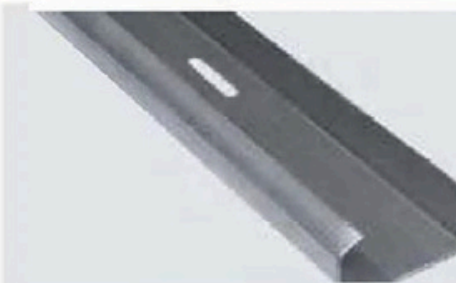

3" Track MAS0310.3

Steel thickness: 2.0mm / 2.5mm
Curve option: R15

Garage Door Parts



Tube Shaft MAS0024

Thickness: 1.5mm / 1.8mm / 2.0mm
Outside diameter: 1"



Shaft Coupler MAS0532

Casting steel / Length: 65mm
For tube shaft only



Tube Shaft with Keyway MAS0124

Thickness: 2.0mm / 3.0mm
Outside diameter: 1" with 1/4 keyway



Shaft Coupler MAS0032

Aluminum / Length: 75mm
For tube shaft with keyway



Solid Shaft with Keyway MAS0224

Outside diameter: 1" with 1/4 keyway



Shaft Coupler MAS0332

Aluminum / Length: 70/90mm
For tube shaft with keyway



Shaft Coupler MAS0132

1" bore with 1/4 keyway
For shaft with keyway



Push Spring MAS0533.15

Total Length: 15"
6" Compression



Shaft Coupler MAS0432

1" bore with 1/4 keyway
For solid shaft

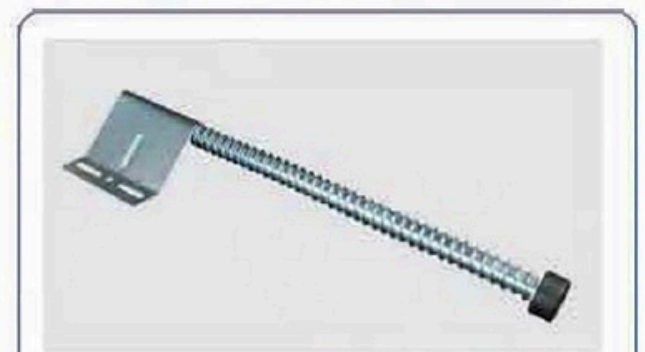

Push Spring MAS0533.27

Total Length: 27"
15" Compression



Straight Shaft Key MAS0035

Length: 75mm / 100mm



Cable MAS0120

7X7 / 7x19
2.38mm / 3.18 mm / 4mm / 5mm

Garage Door Parts



Aluminum Cap MAS0062

For 40mm section panel only
White coated



Aluminum Cap MAS3228

For 50mm section panel only
Match with MAS0129 rubber seal



Aluminum Bottom Seal MAS0028

For 40mm section panel only
Anodized only



Bottom Rubber Seal MAS0029.6

Material: EPDM
Width: 65mm



Aluminum Bottom Seal MAS0128

For 40mm section panel only
For bottom or top panel use



Bottom Rubber Seal MAS0229.17

Material: EPDM
Width: 170mm



Bottom Seal MAS0129

Material: EPDM
Work with Airbag



Side Seal MAS0230

Material: PVC
Work with L profile support only



Side Seal MAS0030

Material: PVC



Top Seal MAS0244

Material: EPDM
Work with SF40S panel only



Side Seal MAS0130

Material: PVC



Side Seal MAS0430

Material: PVC / MBS

>> Garage Door Parts



Emergency Lock MAS0021

With 2mm Cables
For Electrical operation only



Manual Lock MAS0222

Multifunctional, Including Cylinder, Handle,
Cables, Autolatches and swivel



Emergency Lock MAS0121

With 2mm Cables, with Lock cap
For Electrical operation only



Slide Lock MAS0523

Thickness: 2mm / 4mm
Distance: 102mm



T-type Manual Lock MAS0122

Shaft: 5/16" square x 4"



Slide Lock MAS0623

Thickness: 2mm / 4mm



Swivel Latch MAS0038

Thickness 2mm



Passing Door Lock MAS0322

For sectional door passing door only



Auto Latch MAS0039

Thickness: 2.5mm / 12.75mm



Door Closer MAS0049

Aluminum alloy
For residential and industrial use



Autolatch Striker MAS0040

Thickness: 2.0mm / Width 60mm

Height: 7x61 mm

Garage Door Parts

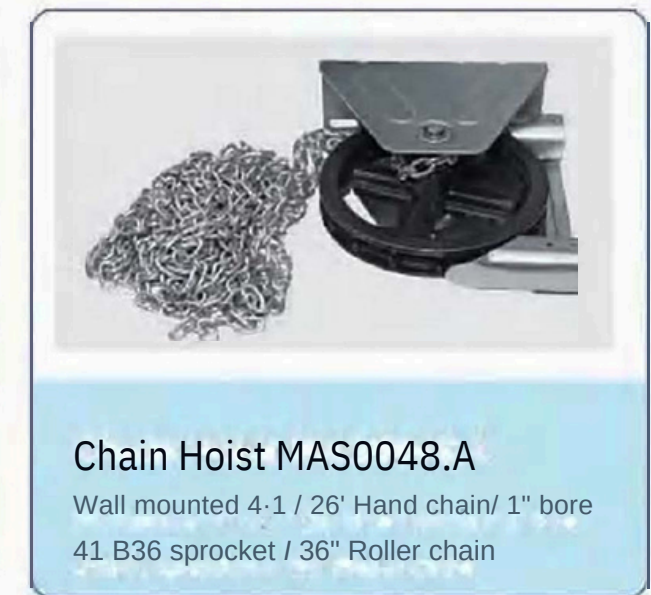

Garage Door Parts



Extension Spring

Antirust oil



Torsion Spring

Oil - Tempered
Wire diameter: 5.0 - 11.5mm



Torsion Spring

Antirust oil
Wire Diameter: 5.0 - 11.5mm



Torsion Spring

Dacromet coating
Wire diameter: 5.0 - 11.5mm



Torsion Spring

Electrophoresis coating
Wire Diameter: 5.0 - 11.5mm



Torsion Spring Filler

For 1" shaft only



Self Drilling Screw

Hexagon Flange
For PU foamed sectional panel only



Carriage Bolt with Nut

M8 X 16
For track assembly



Tapping Screw

Hexagon Flange
For Wood door panel only



Hex Head Bolt with Nut

M8 X 20
For track assembly



Carriage Bolt with Nut

M6 X 12
For track assembly



Wood Screw

Hexagon Flange
For track fixing

Garage Door Parts



Coach Screw
M6 x 90



Side Bracket
4mm, For industrial door use



Coach Screw
M8, c-6Q



Gantry Bracket
For 60mm tube only



Wall Plug 4 way
11 "55mm

