



BUILDER SOLUTION US



Aluminum Doors and Windows

STANDARD COLOR CHOICE

Surface treatment :Powder coated, Electrophoresis,
PVDF,Anodizing,or wood color
Other colors or crafts can contact us for your custom

Power coating

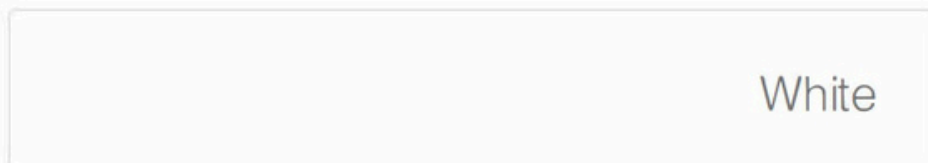
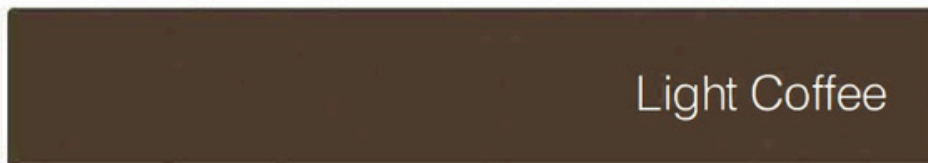
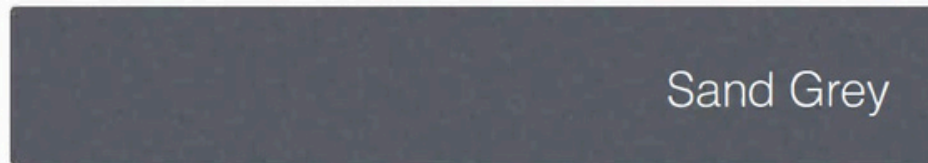

Stock Color

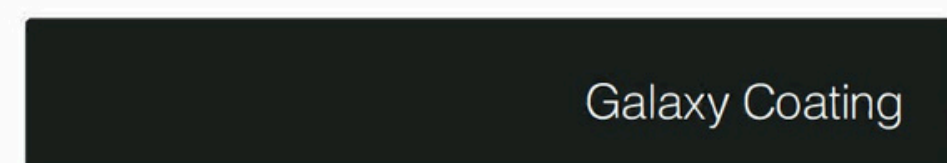
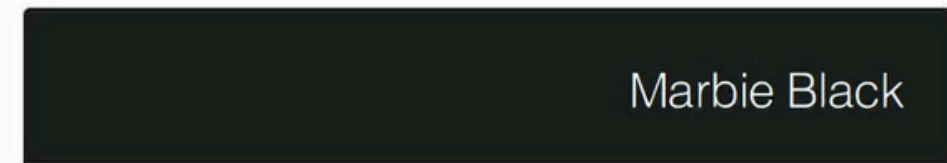

CUSTOMIZE ANY ALUMINUM DOORS AND WINDOWS DESIGN

Please send your drawings and requirements and we will customize them for you

WINDOW

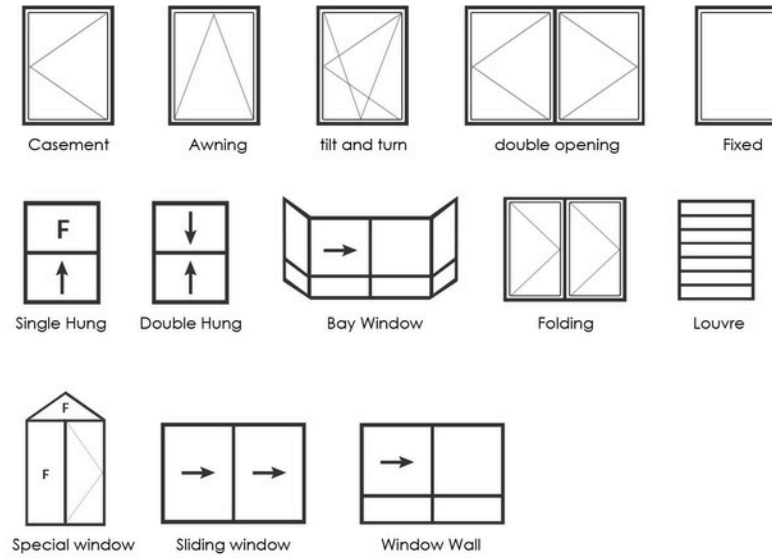

SLIDING WINDOW / DOOR SERIES

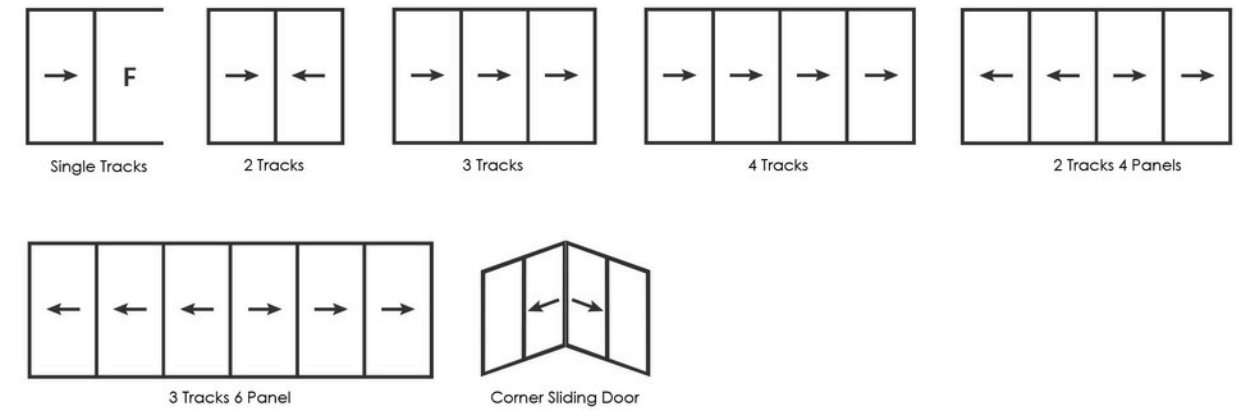

DOOR

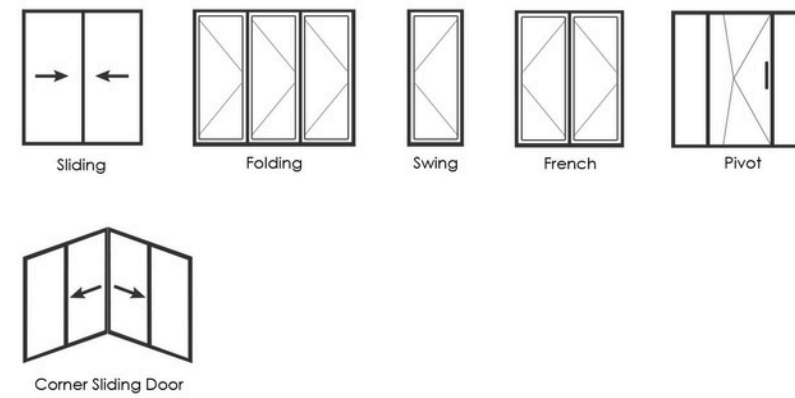

FOLDING SERIES

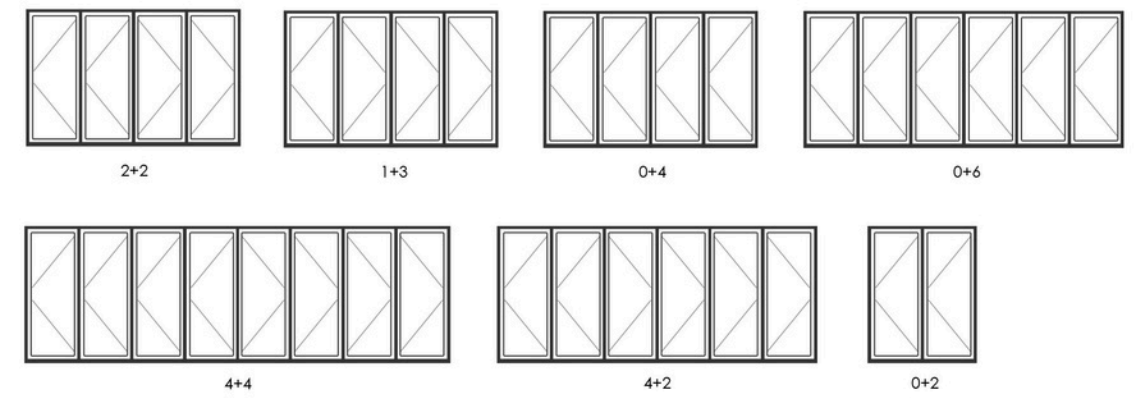

SPECIAL

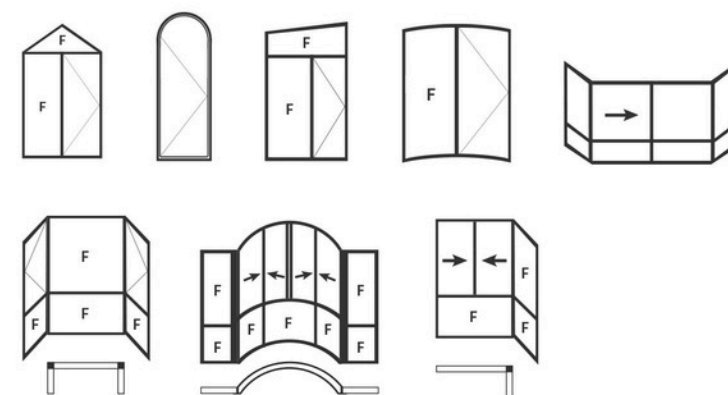

SWING DOOR SERIES

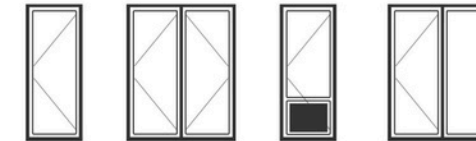

CONTENTS

ALUMINUM THERMAL BREAK CASEMENT WINDOW SERIES

· 63 Series Casement Window	03/04
· E9Y Series Casement Window	05/06
· Y103 Series Casement Windows	07/08
· Y109 Series Casement Windows with Flyscreen	09/10
· K8Y Series Casement Window with Flyscreen	11/12
· K9Y Series Casement Window with Flyscreen	13/14
· Y118 Series Casement Window with Flyscreen	15/16
· Y136 Series Casement Window with Flyscreen	17/18
· 148 Series Casement Window with Flyscreen	19/20
· N93 Series Casement Windows with Flyscreen	21/22
· N103 Series Casement Windows with Flyscreen	23/24
· N112 Series Casement Windows with Flyscreen	25/26

ALUMINUM SLIDING WINDOWS / SLIDING DOOR SERIES

· E2T Series Sliding Window	29/30
· 80 Series Sliding Window	31/32
· 105 Series Narrow Frame Sliding Door / Sliding Window	33/34
· 135D Series Sliding Door	35/36
· 135E Series Heavy Duty Sliding Door	37/38
· 135F Series Sliding Door	39/40
· 135 Series Narrow Frame Sliding Door	41/42
· 16 Series Narrow Frame Sliding Door / 3 Track Top Sliding Door / 4 Track Top Sliding Door	43/44
· 143 Series Thermal Break Sliding Door	45/46

ALUMINUM SWING DOORS SERIES

· 80 Series Interior Swing Door	49/50
· 16 Series Narrow Frame Swing Door	51/52
· 70XT Series Thermal Break Swing Door / French Door	53/54
· P103 Series Thermal Break Swing Door / French Door	55/56

ALUMINUM FOLDING DOORS SERIES

· 78 Series Thermal break folding door	59/60
· 93 Series Thermal break folding door	61/62

ALUMINUM SUNROOM / SKYLIGHT SERIES

· Sunroom	65/66
· Electric Skylight	67/68

OTHER SERIES

· Pivot Door	71/72
· Folding Window	71/72
· Aluminum Shutter	73/74
· Glass Louvre	73/74
· Curtain Wall	75/76
· Single / Double Hung Window	75/76
· Automatic Garage Doors	77/78

ALUMINUM THERMAL BREAK CASEMENT WINDOW SERIES



- Three-way sealing design isobaric principle drainage
- National utility patent-six-point lock on all sides
- National Practical Patent-Built-in Diamond Wire Pressing Line



SERIES CASEMENT

63

CASEMENT WINDOW

- Thermal break aluminum profile
- National patent : Six-Point Lock



PRODUCT PARAMETES

DESCRIPTION	PROFILE THINCKNESS	1.6mm
	OPENING WAY	Outward Opening / Awning
	GLASS	5mm+20A+5mm
	HARDWARE COLOR	Black/Silver
	PROFILE COLOR	Black/White/Gray/Coffee(Powder Coating)
	HARDWARE	HOPPE Handle
	HINGE	GU Hinge
	LOCK POINT	Stainless steel Six Point Lock
	AVAILABLE SIZE	Opening Panel (Width: 350-750/Height: 400-1500) Each Fixed panel ≤6m²

CUSTOMIZED

- 23A Magnet Blinds
- 27A Electric / Light Blinds
- Casement Stopper
- Hidden accessories For Awning
- Fingerprint Handle/Password Handle/Key handle





SERIES CASEMENT

E9Y CASEMENT WINDOW

- Thermal break aluminum profile
- The flyscreen panel with Aluminum corner protector
- Anti-theft design for flyscreen



PRODUCT PARAMETES

DESCRIPTION	PROFILE THINCKNESS	1.8mm
	OPENING WAY	Outward Opening / Awning
	GLASS	5mm+27A+5mm
	HARDWARE COLOR	Black / Silver / Bronze
	PROFILE COLOR	Black/White/Gray/Coffee(Powder Coating)
	HARDWARE	WEHAG Handle
	HINGE	WEHAG Hinge
	LOCK POINT	Customized Black Two Point Lock
	ANTI-FALL ROPE	Standard Aluminum Anti -fall Rope (Bear weight 150KG)
	AVAILABLE SIZE	Opening Panel(Width: 350-750/Height: 400-1500) Each Fixed panel ≤6 m²

CUSTOMIZED

- 23A Magnet Blinds
- 27A Electric / Light Blinds
- Japan Import Flyscreen
- Fingerprint Handle/Password Handle/Key handle
- Casement Stopper
- Insulation Cotton
- Hidden accessories For Awning





SERIES CASEMENT

Y103 CASEMENT WINDOW

- Thermal break aluminum profile
- National patent : Six-Point Lock



PRODUCT PARAMETES

DESCRIPTION	PROFILE THINCKNESS	2.0mm
	OPENING WAY	Outward Opening / Awning
	GLASS	5mm+27A+5mm
	HARDWARE COLOR	Black/Silver
	PROFILE COLOR	Black/White/Gray/Coffee(Powder Coating)
	HARDWARE	WEHAG Handle
	HINGE	WEHAG Hinge
	LOCK POINT	Customized Black Six Point Lock
	AVAILABLE SIZE	Opening Panel (Width: 350-750/Height: 400-1500) Each Fixed panel ≤12m²

CUSTOMIZED

- 23A Magnet Blinds
- 27A Electric / Light Blinds
- Casement Stopper
- Fingerprint Handle/Password Handle/Key handle
- Hidden accessories For Awning





SERIES CASEMENT

Y109

CASEMENT WINDOW WITH FLYSCREEN

- Thermal break aluminum profile
- The flyscreen panel with Aluminum corner protector
- 0.8mm SUS 304 stainless steel screen



PRODUCT PARAMETES

DESCRIPTION	PROFILE THINCKNESS	1.8mm
	OPENING WAY	Outward Opening / Awning
	GLASS	5mm+27A+5mm
	HARDWARE COLOR	Black/Silver
	PROFILE COLOR	Black/White/Gray/Coffee(Powder Coating)
	HARDWARE	WEHAG Handle
	HINGE	WEHAG Hinge
	LOCK POINT	Customized Black Two Point Lock
	AVAILABLE SIZE	Opening Panel (Width: 350-750/Height: 400-1500) Each Fixed panel ≤6m²

CUSTOMIZED

- 23A Magnet Blinds
- 27A Electric / Light Blinds
- Insulation Cotton
- Japan Import Flyscreen
- Casement Stopper
- Fingerprint Handle/Password Handle/Key handle
- Hidden accessories For Awning
- Fixed Fence Or Removable Fence



SERIES CASEMENT

K8Y CASEMENT WINDOW WITH FLYSCREEN

- Thermal break aluminum profile
- National patent : Six-Point Lock
- Anti-theft design for flyscreen
- Hidden drainage
- Triple insulated strip
- Flat design for Indoor & Outdoor



PRODUCT PARAMETES

DESCRIPTION	PROFILE THINCKNESS	2.0mm
	OPENING WAY	Outward Opening / Awning
	GLASS	5mm+27A+5mm
	HARDWARE COLOR	Black / Silver / Bronze
	PROFILE COLOR	Black/White/Gray/Coffee(Powder Coating)
	HARDWARE	WEHAG Handle
	HINGE	WEHAG Hinge
	LOCK POINT	Customized Black Six Point Lock
	ANTI-FALL ROPE	Standard Aluminum Anti -fall Rope (Bear weight 150KG)
	AVAILABLE SIZE	Opening Panel(Width: 400-750/Height: 400-1500) Each Fixed panel ≤12 m²

CUSTOMIZED

- 26A Magnet Blinds
- 27A Electric / Light Blinds
- Japan Import Flyscreen
- Fingerprint Handle/Password Handle/Key handle
- Casement Stopper





SERIES CASEMENT

K9Y CASEMENT WINDOW WITH FLYSCREEN

- Thermal break aluminum profile
- National patent : Six-Point Lock
- Anti-theft design for flyscreen
- Hidden drainage
- Triple insulated strip
- Flat design for Indoor & Outdoor



PRODUCT PARAMETES

DESCRIPTION	PROFILE THINCKNESS	2.0mm
	OPENING WAY	Outward Opening / Awning
	GLASS	5mm+27A+5mm
	HARDWARE COLOR	Black / Silver / Bronze
	PROFILE COLOR	Black/White/Gray/Coffee(Powder Coating)
	HARDWARE	WEHAG Handle
	HINGE	WEHAG Hinge
	LOCK POINT	Customized Black Six Point Lock
	ANTI-FALL ROPE	Standard Aluminum Anti -fall Rope (Bear weight 150KG)
	AVAILABLE SIZE	Opening Panel(Width: 400-750/Height: 400-1500) Each Fixed panel ≤12 m²

CUSTOMIZED

- 26A Magnet Blinds
- 27A Electric / Light Blinds
- Japan Import Flyscreen
- Fingerprint Handle/Password Handle/Key handle
- Casement Stopper
- Fixed Fence 、 Removable Fence or open Security fence
- Insulation Cotton

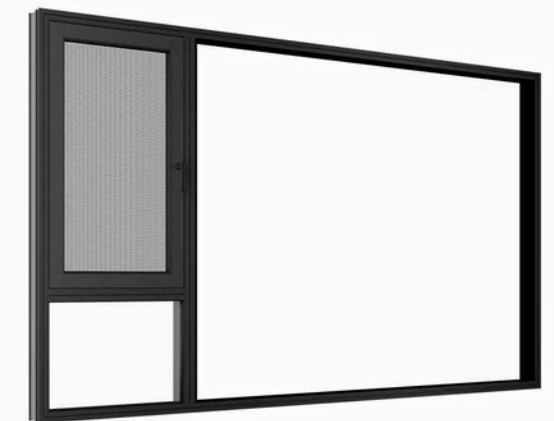



SERIES CASEMENT

Y118

CASEMENT WINDOW WITH FLYSCREEN

- Thermal break aluminum profile
- The flyscreen panel with Aluminum corner protector
- 0.8mm SUS 304 stainless steel screen
- Hidden drainage design



PRODUCT PARAMETES

DESCRIPTION	PROFILE THINCKNESS	1.4mm
	OPENING WAY	Outward Opening / Awning
	GLASS	5mm+27A+5mm
	HARDWARE COLOR	Black/Silver
	PROFILE COLOR	Black/White/Gray/Coffee(Powder Coating)
	HARDWARE	WEHAG Handle
	HINGE	WEHAG Hinge
	LOCK POINT	Customized Black Six Point Lock
	AVAILABLE SIZE	Opening Panel (Width: 350-750/Height: 400-1500) Each Fixed panel ≤6m²

CUSTOMIZED

- 23A Magnet Blinds
- 27A Electric / Light Blinds
- Insulation Cotton
- Japan Import Flyscreen
- Casement Stopper
- Fingerprint Handle/Password Handle/Key handle
- Hidden accessories For Awning
- Security Fence
- 5+12A+5+12A+5 Glass

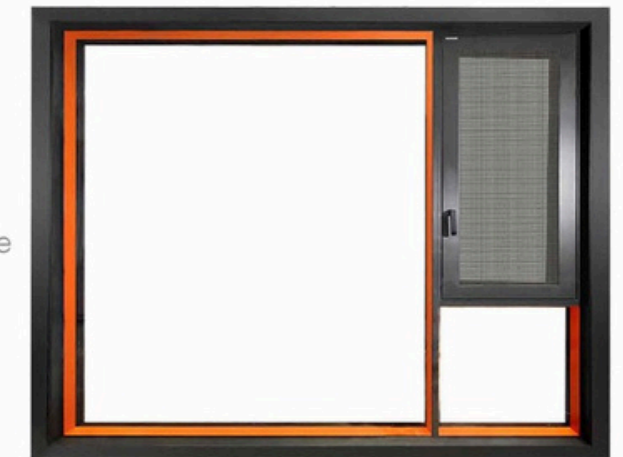



SERIES CASEMENT

Y136

CASEMENT WINDOW WITH FLYSCREEN

- Thermal break aluminum profile
- National patent : Six-Point Lock
- 0.8mm SUS 304 stainless steel screen

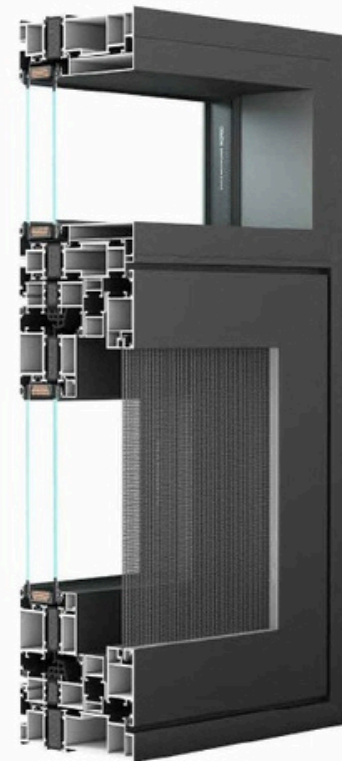

PRODUCT PARAMETES

DESCRIPTION	PROFILE THINCKNESS	2.0mm
	OPENING WAY	Outward Opening / Awning
	GLASS	5mm+27A+5mm
	HARDWARE COLOR	Black/Silver
	PROFILE COLOR	Black/White/Gray/Coffee(Powder Coating)
	HARDWARE	WEHAG Handle
	HINGE	WEHAG Hinge
	LOCK POINT	Customized Black Six Point Lock
	AVAILABLE SIZE	Opening Panel (Width: 350-750/Height: 400-1500) Each Fixed panel ≤ 12m²

CUSTOMIZED

- 23A Magnet Blinds
- 27A Electric / Light Blinds
- Insulation Cotton
- Japan Import Flyscreen
- Casement Stopper
- Fingerprint Handle/Password Handle/Key handle
- Fixed Fence Or Opening Fence
- Security Fence





SERIES CASEMENT

Y148

CASEMENT WINDOW WITH FLYSCREEN

- Thermal break aluminum profile
- National patent : Six-Point Lock
- 0.8mm SUS 304 stainless steel screen

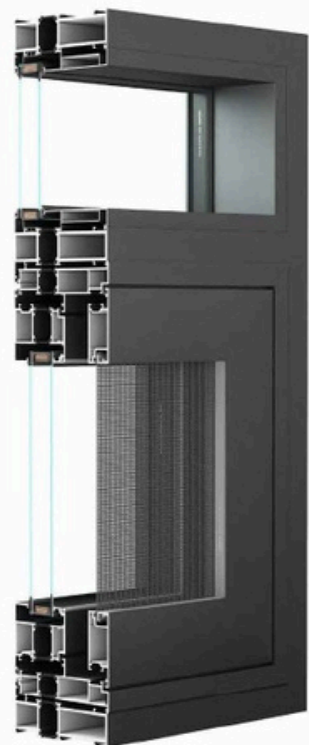

PRODUCT PARAMETES

DESCRIPTION	PROFILE THINCKNESS	3.0mm
	OPENING WAY	Outward Opening / Awning
	GLASS	5mm+27A+5mm
	HARDWARE COLOR	Black/Silver
	PROFILE COLOR	Black/White/Gray/Coffee(Powder Coating)
	HARDWARE	Germany HOPPE
	HINGE	GU Hinge
	LOCK POINT	Stainless steel Black Six Point Lock
	AVAILABLE SIZE	Opening Panel (Width: 350-750/Height: 400-1500) Each Fixed panel ≤12m²

CUSTOMIZED

- 23A Magnet Blinds
- Security Fence
- Security Fence
- Casement Stopper
- Fingerprint Handle/Password Handle/Key handle
- Hidden accessories For Awning





SERIES CASEMENT

N93 CASEMENT WINDOW WITH FLYSCREEN

- Thermal break aluminum profile
- National patent : Six-Point Lock
- 0.8mm SUS 304 stainless steel screen

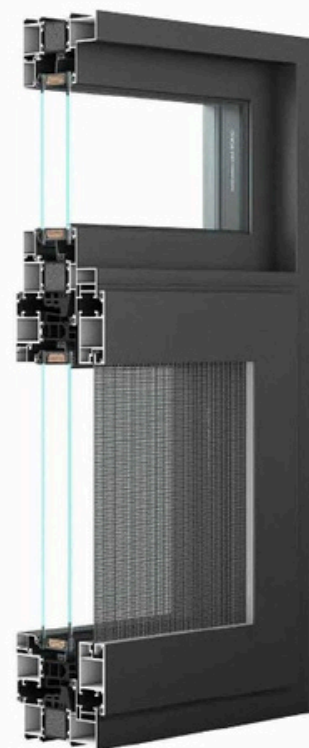

PRODUCT PARAMETES

DESCRIPTION	PROFILE THINCKNESS	1.4mm
	OPENING WAY	Inward Opening / Tilt and Turn
	GLASS	5mm+27A+5mm
	HARDWARE COLOR	Black/Silver
	PROFILE COLOR	Black/White/Gray/Coffee(Powder Coating)
	HARDWARE	WEHAG Handle
	HINGE	WEHAG Hinge
	LOCK POINT	WEHAG Lock point
	AVAILABLE SIZE	Opening Panel (Width: 508-1000/Height: 500-2000) Each Fixed panel ≤6m²

CUSTOMIZED

- 23A Magnet Blinds
- 27A Electric / Light Blinds
- Insulation Cotton
- Japan Import Flyscreen
- Glass Fence
- Fingerprint Handle/Password Handle/Key handle
- 5+12A+5+12A+5 Glass
- Hidden 180 Degree Tilt and Turn Accessories





SERIES CASEMENT

N103

CASEMENT WINDOWS WITH FLYSCREEN

- Thermal break aluminum profile
- Tilt and Turn Window
- 0.8mm SUS 304 stainless steel screen
- 35.3mm Super-wide custom made nylon insulation strips



PRODUCT PARAMETES

DESCRIPTION	PROFILE THINCKNESS	2.0mm
	OPENING WAY	Inward Opening / Tilt and Turn
	GLASS	5mm+27A+5mm
	HARDWARE COLOR	Black/Silver
	PROFILE COLOR	Black/White/Gray/Coffee(Powder Coating)
	HARDWARE	WEHAG Handle
	HINGE	WEHAG Hinge
	LOCK POINT	WEHAG Lock point
	AVAILABLE SIZE	Opening Panel (Width: 508-1000/Height: 500-2000) Each Fixed panel ≤6m ²

CUSTOMIZED

- 23A Magnet Blinds
- 27A Electric / Light Blinds
- Insulation Cotton
- Japan Import Flyscreen
- Glass Fence
- Fingerprint Handle/Password Handle/Key handle
- 5+12A+5+12A+5 Glass
- Hidden 180 Degree Tilt and Turn Accessories





SERIES CASEMENT

N112

CASEMENT WINDOWS WITH FLYSCREEN

- Thermal break aluminum profile
- Tilt and Turn Window
- 0.8mm SUS 304 stainless steel screen
- 44mm Super-wide Nylon insulation strip

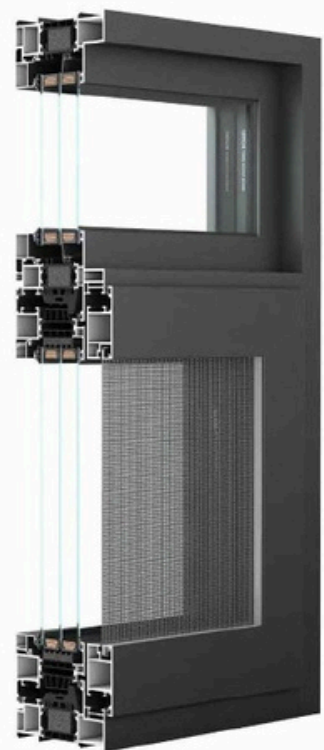

PRODUCT PARAMETES

DESCRIPTION	PROFILE THINCKNESS	2.0mm
	OPENING WAY	Inward Opening / Tilt and Turn
	GLASS	5mm+27A+5mm
	HARDWARE COLOR	Black/Silver
	PROFILE COLOR	Black/White/Gray/Coffee(Powder Coating)
	HARDWARE	WEHAG Handle
	HINGE	WEHAG Hinge
	LOCK POINT	WEHAG Lock point
	AVAILABLE SIZE	Opening Panel (Width: 508-1000/Height: 500-2000) Each Fixed panel ≤6m²

CUSTOMIZED

- 23A Magnet Blinds
- 27A Electric / Light Blinds
- Insulation Cotton
- Japan Import Flyscreen
- Glass Fence
- Fingerprint Handle/Password Handle/Key handle
- 5+12A+5+12A+5 Glass
- Hidden 180 Degree Tilt and Turn Accessories



ALUMINUM SLIDING WINDOW / DOOR SERIES



- Three-way sealing design isobaric principle drainage
- National utility patent-six-point lock on all sides
- National Practical Patent-Built-in Diamond Wire Pressing Line

BUILDER SOLUTION US



SERIES SLIDING

E2T THERMAL BREAK SLIDING WINDOW

- Thermal break aluminum profile
- Anti-theft design for flyscreen
- High low track design -Inside high outside low
- Hidden drainage



PRODUCT PARAMETES

DESCRIPTION	PROFILE THINCKNESS	1.8mm
	OPENING WAY	Two Tracks / Three Tracks with Flyscreen
	GLASS	5mm+15A+5mm
	HARDWARE COLOR	Silver / Bronze
	PROFILE COLOR	Black/White/Gray/Coffee(Powder Coating)
	FLUSH LOCK	Aluminum Flush Lock with Key
	WHEEL	Customized Mute two Wheel
	LOCK POINT	Automatic Lock
	AVAILABLE SIZE	Opening Panel(Width: 350-1100/Height: 500-2100)

CUSTOMIZED

- Sliding Stopper

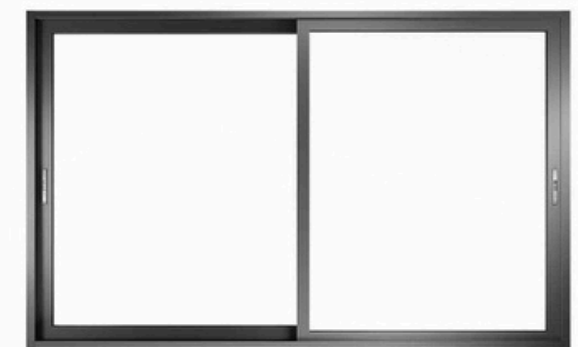



SERIES SLIDING

80Z SLIDING WINDOW

- High Low Track Design, Waterproof
- Hidden drainage design



PRODUCT PARAMETES

DESCRIPTION	PROFILE THINCKNESS	1.4mm
	OPENING WAY	Two Tracks / Three Tracks
	GLASS	5mm+15A+5mm
	HARDWARE COLOR	Silver / Golden
	PROFILE COLOR	Black/White/Gray/Coffee(Powder Coating)
	FLUSH LOCK	HOPO Automatic Hook Lock
	LOCK POINT	HOPO Lock Point
	WHEEL	Customized Mute two Wheel
	AVAILABLE SIZE	Opening Panel (Width: 350-1100/Height: 500-2100)

CUSTOMIZED

- Flush Lock with Key
- Sliding Stopper
- Lower track optional Copper strip and high rail





SERIES SLIDING

105Z

NARROW FRAME SLIDING DOOR / SLIDING WINDOW

- Narrow Frame Design
- Stainless Steel Lock Point

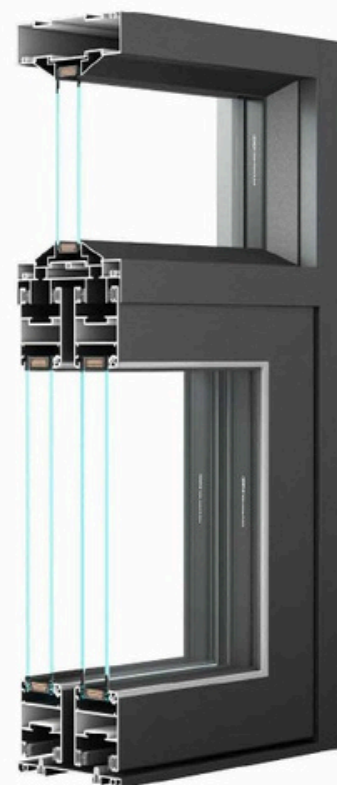

PRODUCT PARAMETES

DESCRIPTION	PROFILE THINCKNESS	1.3mm
	OPENING WAY	Two Tracks / Three Tracks
	GLASS	5mm+12A+5mm
	HARDWARE COLOR	Silver/Black
	PROFILE COLOR	Black/White/Gray/Coffee(Powder Coating)
	FLUSH LOCK	PAG Aluminum Hook Lock
	LOCK POINT	Stainless Steel Single Hook Lock
	WHEEL	Customized Mute two Wheel
	AVAILABLE SIZE	Opening Panel (Width: 350-1200 / Height: 500-2700)

CUSTOMIZED

- Sliding Stopper
- Anti Typhoon Anti Balance Wheel
- Copper strip, 35 high rail, high rail, low rail





SERIES SLIDING

135D SLIDING DOOR



PRODUCT PARAMETES

DESCRIPTION	PROFILE THINCKNESS	1.8mm
	OPENING WAY	Two Tracks / Three Tracks
	GLASS	5mm+27A+5mm
	HARDWARE COLOR	Silver / Golden
	PROFILE COLOR	Black/White/Gray/Coffee(Powder Coating)
	FLUSH LOCK	PAG Aluminum Hook Lock
	HANDLE	310mm Aluminum Handle
	LOCK POINT	Stainless Steel Single Hook Lock
	WHEEL	Customized Mute two Wheel
	AVAILABLE SIZE	Opening Panel (Width: 580-1800 / Height: 800-3000)

CUSTOMIZED

- 23A Magnet Blinds
- 27A Electric / Light Blinds
- Dashpot
- Fingerprint Lock
- Lock Core With Key
- Copper strip, high rail, 35 high rail, low rail, waterproof high rail is available





SERIES SLIDING

135E HEAVY DUTY SLIDING DOOR

· Heavy Duty Sliding Door



PRODUCT PARAMETES

DESCRIPTION	PROFILE THINCKNESS	1.8mm
	OPENING WAY	Two Tracks / Three Tracks
	GLASS	5mm+27A+5mm
	HARDWARE COLOR	Silver / Golden
	PROFILE COLOR	Black/White/Gray/Coffee(Powder Coating)
	FLUSH LOCK	PAG Aluminum Hook Lock
	HANDLE	310mm Aluminum Handle
	LOCK POINT	Stainless Steel Single Hook Lock
	WHEEL	Customized Mute two Wheel
	AVAILABLE SIZE	Opening Panel (Width: 580-1800 / Height: 800-3000)

CUSTOMIZED

- 23A Magnet Blinds
- 27A Electric / Light Blinds
- Dashpot
- Fingerprint Lock
- Lock Core With Key
- Copper strip, high rail, 35 high rail, low rail, waterproof high rail is available





SERIES SLIDING

135F SLIDING DOOR

- Anti-typhoon and Anti-swing upper wheel
- Floor drain drainage structure



PRODUCT PARAMETES

DESCRIPTION	PROFILE THINCKNESS	2.2mm
	OPENING WAY	Two Tracks / Three Tracks
	GLASS	5mm+27A+5mm
	HARDWARE COLOR	Silver
	PROFILE COLOR	Black/White/Gray/Coffee(Powder Coating)
	FLUSH LOCK	WEHAG Aluminum Flush Lock
	HANDLE	HOPO Aluminum Handle
	LOCK POINT	304 Stainless Steel Single Hook Lock
	WHEEL	Customized Mute Four Wheel
	AVAILABLE SIZE	Opening Panel (Width: 580-2000 / Height: 800-3000)

CUSTOMIZED

- 26A Magnet Blinds
- 27A Electric / Light Blinds
- Lock Core With Key
- Fingerprint Lock
- Dashpot
- Copper strip,Hidden drainage high rails, high rail,35 high rail, low rail, waterproof high rail is available





SERIES SLIDING

135 NARROW FRAME SLIDING DOOR

- Narrow Frame Design
- Stainless Steel Lock Point



PRODUCT PARAMETES

DESCRIPTION	PROFILE THINCKNESS	1.8mm
	OPENING WAY	Two Tracks / Three Tracks
	GLASS	5mm+27A+5mm
	HARDWARE COLOR	Silver / Black
	PROFILE COLOR	Black/White/Gray/Coffee(Powder Coating)
	FLUSH LOCK	PAG Aluminum Hook Lock
	LOCK POINT	Stainless Steel Single Hook Lock
	WHEEL	Customized Mute two Wheel
	AVAILABLE SIZE	Opening Panel (Width: 580-1800 / Height: 800-3000)

CUSTOMIZED

- 23A Magnet Blinds
- 27A Electric / Light Blinds
- Lock Core With Key
- Copper strip, high rail,35 high rail, low rail, waterproof high rail is available





SERIES SLIDING

16

NARROW FRAME SLIDING DOOR

3 TRACK TOP SLIDING DOOR /
4 TRACK TOP SLIDING DOOR

- Narrow Frame Design
- Mute pulley



PRODUCT PARAMETES

DESCRIPTION	PROFILE THINCKNESS	1.4mm
	OPENING WAY	Two Tracks / Three Tracks / Four Tracks
	GLASS	5mm+12A+5mm
	HARDWARE COLOR	Black
	PROFILE COLOR	Black/White/Gray/Coffee(Powder Coating)
	FLUSH LOCK	Mini Aluminum Profile Lock
	LOCK POINT	Stainless Steel Double Hook Lock
	WHEEL	Opac Mute Hung Wheel
	AVAILABLE SIZE	Opening Panel (Width: 580-1800 / Height: 800-3000)

CUSTOMIZED

- 8mm Single Glass
- Dashpot





SERIES SLIDING

143

THERMAL BREAK SLIDING DOOR

- Thermal break aluminum profile
- Narrow Frame Design
- 2/3/4 Tracks is available
- can do Lift and Sliding Door

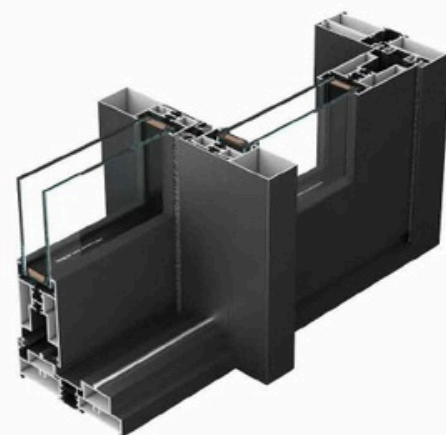

PRODUCT PARAMETES

DESCRIPTION	PROFILE THINCKNESS	2.2mm
	OPENING WAY	Two Tracks / Three Tracks / Four Tracks
	GLASS	5mm+27A+5mm
	HARDWARE COLOR	Silver / Golden
	PROFILE COLOR	Black/White/Gray/Coffee(Powder Coating)
	FLUSH LOCK	HOPO Hook Lock
	HANDLE	HOPO 340mm Aluminum Handle
	LOCK POINT	304 Stainless Steel Single Hook Lock
	WHEEL	Customized Mute Four Wheel
	AVAILABLE SIZE	Opening Panel (Width: 580-1800 / Height: 800-3000)

CUSTOMIZED

- 23A Magnet Blinds
- 27A Electric / Light Blinds
- Fingerprint Lock
- Copper strip, high rail



ALUMINUM SWING DOORS SERIES



- Three-way sealing design isobaric principle drainage
- National utility patent-six-point lock on all sides
- National Practical Patent-Built-in Diamond Wire Pressing Line

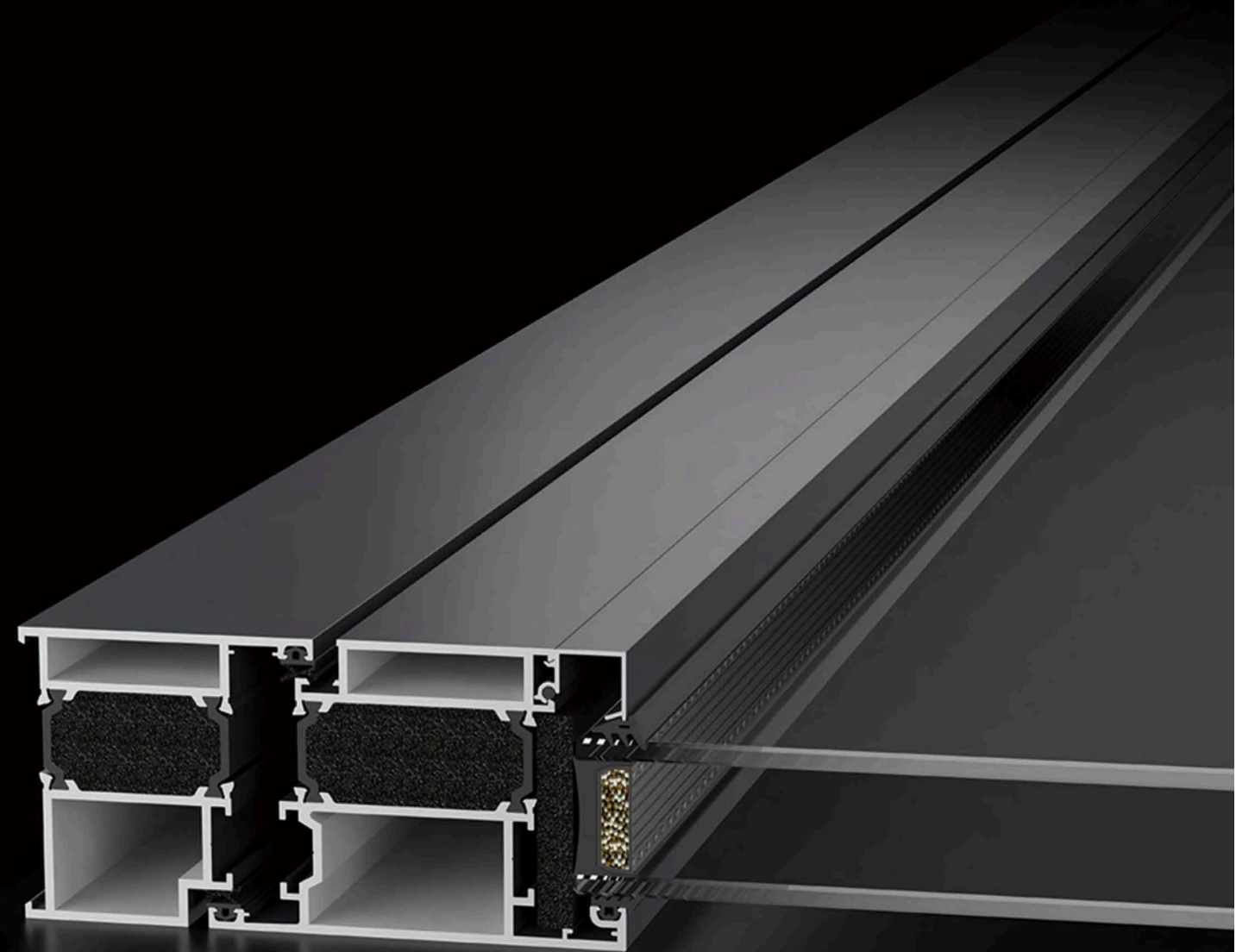



SERIES SWING

80

INTERIOR SWING DOOR



PRODUCT PARAMETES

DESCRIPTION	PROFILE THINCKNESS	1.2mm
	OPENING WAY	Outward or Inward
	GLASS	4mm+9A+4mm
	PROFILE COLOR	Black/White/Gray/Coffee(Powder Coating)
	HANDLE	Aluminum Handle
	AVAILABLE SIZE	Opening Panel (Width: 350-850/Height: 400-2200)

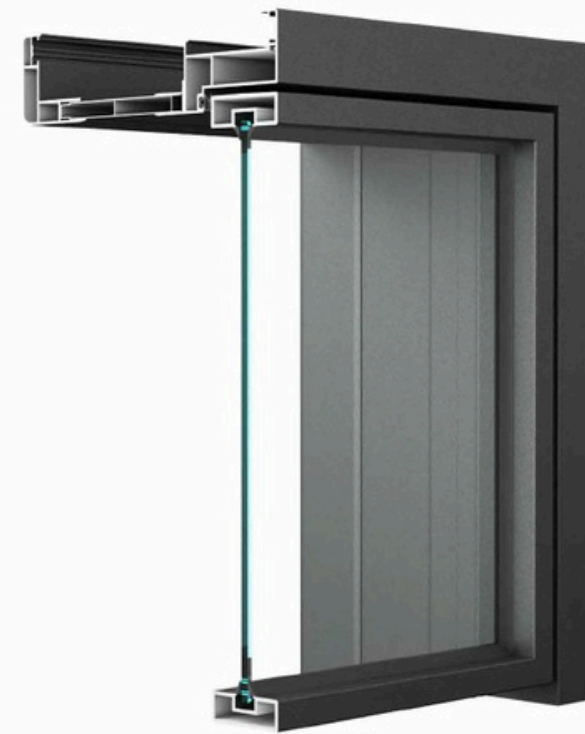

SERIES SWING

16 NARROW FRAME SWING DOOR

· Narrow Frame Design



PRODUCT PARAMETES

DESCRIPTION	PROFILE THINCKNESS	1.4mm
	OPENING WAY	Outward or Inward
	GLASS	5mm+12A+5mm
	HARDWARE COLOR	Black
	PROFILE COLOR	Black/White/Gray/Coffee(Powder Coating)
	HANDLE	Mini Aluminum Handle
	LOCK POINT	Magnetic Lock
	AVAILABLE SIZE	Opening Panel (Width: 350-850/Height: 400-2200)



SERIES SWING

70XT

THERMAL BREAK SWING DOOR / FRENCH DOOR

- Thermal break aluminum profile
- Low Track Design
- High Waterproof



PRODUCT PARAMETES

DESCRIPTION	PROFILE THINCKNESS	2.2mm
	OPENING WAY	Single Door / Double Door
	GLASS	5mm+27A+5mm
	HARDWARE COLOR	Silver / Black
	PROFILE COLOR	Black/White/Gray/Coffee(Powder Coating)
	HANDLE	HOPO Double Handle
	HINGE	Column Hinge
	LOCK POINT	Stainless steel two-point lock
	AVAILABLE SIZE	Opening Panel (Width: 350-1100/Height: 400-2800)

CUSTOMIZED

- Flush Lock with Key
- Sliding Stopper
- Fingerprint Lock





SERIES
SWING

P103

THERMAL BREAK SWING DOOR / FRENCH DOOR

- Thermal break aluminum profile
- Low Track Design



PRODUCT PARAMETES

DESCRIPTION	PROFILE THINCKNESS	2.0mm
	OPENING WAY	Single Door / Double Door
	GLASS	5mm+27A+5mm
	HARDWARE COLOR	Silver / Black
	PROFILE COLOR	Black/White/Gray/Coffee(Powder Coating)
	HANDLE	HOPO Double Handle
	HINGE	Column Hinge
	LOCK POINT	Customized Black Safe Point Lock
	AVAILABLE SIZE	Opening Panel (Width: 350-1100/Height: 400-2800)

CUSTOMIZED

- Flush Lock with Key
- Sliding Stopper
- Fingerprint Lock



DIAMOND



ALUMINUM FOLDING DOORS SERIES



- Three-way sealing design isobaric principle drainage
- National utility patent-six-point lock on all sides
- National Practiac Patent-Built-in Diamond Wire Pressing Line

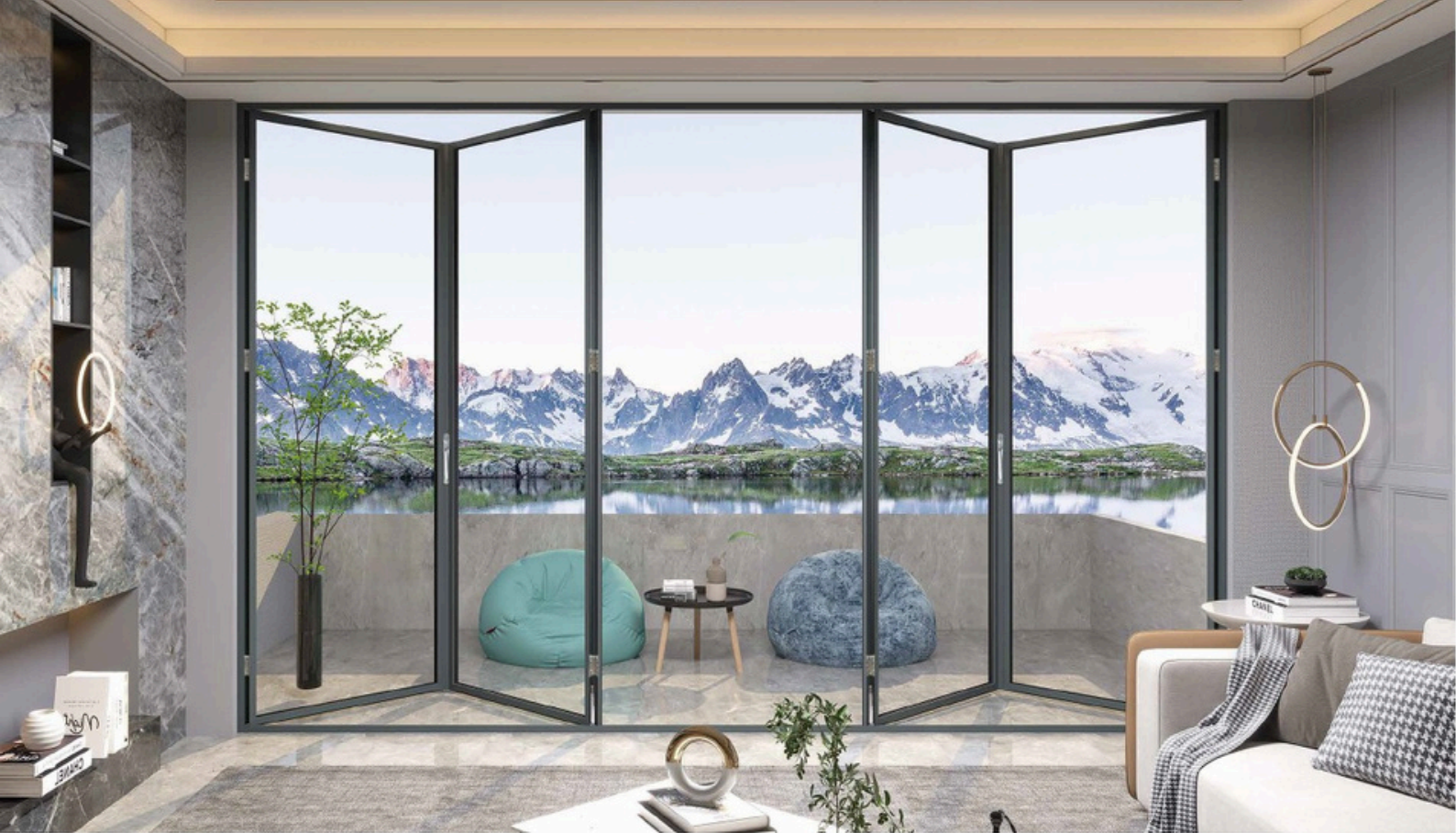

SERIES FOLDING

78

THERMAL BREAK FOLDING DOOR

- Thermal break aluminum profile
- Anti-clamping hand



PRODUCT PARAMETES

DESCRIPTION	PROFILE THINCKNESS	1.6mm
	OPENING WAY	Glass Panel Inward Folding / Outward Opening
	GLASS	5mm+27A+5mm
	HARDWARE COLOR	Silver / Black
	PROFILE COLOR	Black/White/Gray/Coffee(Powder Coating)
	HANDLE	Kerssemberg Handle
	HINGE	Kerssemberg Hidden Hinge
	LOCK POINT	Kerssemberg Lock
	AVAILABLE SIZE	Opening Panel (Width: 500-800/Height: 1000-2800)

CUSTOMIZED

- 23A Magnet Blinds
- 27A Electric / Light Blinds
- Folding Flyscreen





SERIES FOLDING

93

THERMAL BREAK FOLDING DOOR

- Thermal break aluminum profile
- Anti-clamping hand
- Hidden hinge



PRODUCT PARAMETES

DESCRIPTION	PROFILE THINCKNESS	2.0mm
	OPENING WAY	Glass Panel Inward Folding / Outward Opening
	GLASS	5mm+27A+5mm
	HARDWARE COLOR	Silver
	PROFILE COLOR	Black/White/Gray/Coffee(Powder Coating)
	HANDLE	Kersseberg Handle
	HINGE	Kersseberg Hidden Hinge
	LOCK POINT	Kersseberg Lock
	AVAILABLE SIZE	Opening Panel (Width: 500-800/Height: 1000-3800)

CUSTOMIZED

- 23A Magnet Blinds
- 27A Electric / Light Blinds
- Folding Flyscreen





ALUMINUM SUNROOM / SKYLIGHT SERIES



- Three-way sealing design isobaric principle drainage
- National utility patent-six-point lock on all sides
- National Practical Patent-Built-in Diamond Wire Pressing Line

BUILDER SOLUTION US



SERIES SUNROOM

SUNROOM



PRODUCT PARAMETES

DESCRIPTION	PROFILE THICKNESS	2.0-4.0mm
	GLASS	5mm+1.14PVB+5mm
	PROFILE COLOR	Black/White/Gray/Coffee(Powder Coating)

CUSTOMIZED

- Casement Electric Skylight
- 27A Electric Shading System





ELECTRIC SKYLIGHT

ELECTRIC SKYLIGHT

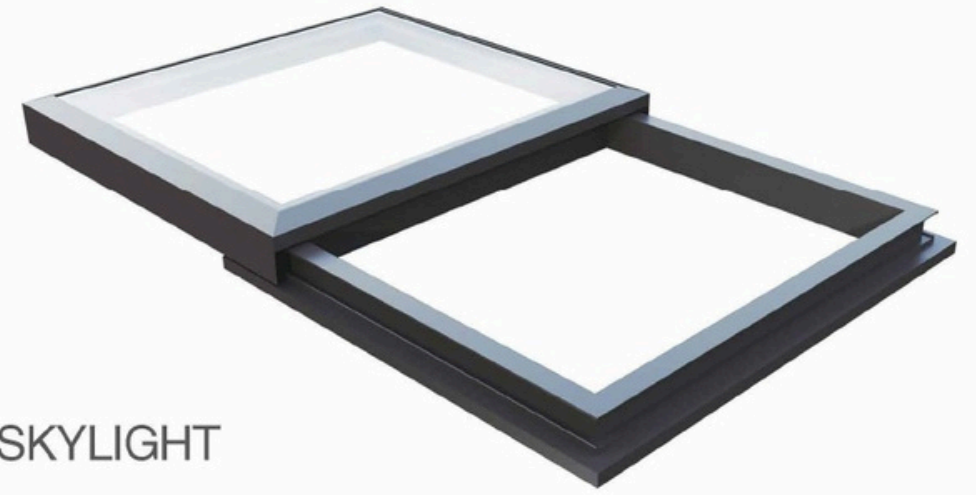

SLIDING ROOF SKYLIGHT

SLIDING ROOF SKYLIGHT



OTHER SERIES



- Three-way sealing design isobaric principle drainage
- National utility patent-six-point lock on all sides
- National Practical Patent-Built-in Diamond Wire Pressing Line



BUILDER SOLUTION US



PIVOT
DOOR

PIVOT DOOR

PRODUCT PARAMETES

DESCRIPTION	ALUMINUM THICKNESS	2.0mm
	GLASS STANDARD	Double glazing 5mm+12A+5mm

PRODUCT PARAMETES

DESCRIPTION	ALUMINUM THICKNESS	2.0mm
	GLASS STANDARD	Double glazing 5mm+12A+5mm
	HARDWARE STANDARD	Kerssenberg

FOLDING WINDOW

FOLDING
WINDOW





ALUMINUM SHUTTER

ALUMINUM SHUTTER

PRODUCT PARAMETES

DESCRIPTION	ALUMINUM THICKNESS	1.4mm
-------------	--------------------	-------

PRODUCT PARAMETES

DESCRIPTION	ALUMINUM THICKNESS	1.4mm
	GLASS STANDARD	Double glazing 5mm+12A+5mm

GLASS LOUVRE

GLASS LOUVRE





CURTAIN WALL

CURTAIN WALL

PRODUCT PARAMETES

DESCRIPTION	ALUMINUM THICKNESS	2.0mm-3.0mm
	GLASS STANDARD	Double glazing 5mm+12A+5mm

PRODUCT PARAMETES

DESCRIPTION	ALUMINUM THICKNESS	1.4mm
	GLASS STANDARD	Double glazing 5mm+12A+5mm

SINGLE / DOUBLE HUNG WINDOW

SINGLE / DOUBLE HUNG WINDOW





AUTOMATIC
GARAGE DOORS

AUTOMATIC GARAGE DOORS

PRODUCT PARAMETES

SERIES	Automatic Garage Doors
PROFILE THICKNESS	2.5mm aluminum profile thickness
CONTROL MODEL	Remote Control (Standard),Manual
OPENER	800N/1000N/1200N/1500N/1800N (Based on doorway's size)
GLASS	5mm tempered glass ; Clear glass ; Frosted Glass (Standard)
HINGES	2.5mm plate galvanized steel
ROLLERS	Standard (2" or 3"), Heavy Duty (2" or 3")

