





## RSF Trading Innovation & Builder Solutions

 858-999-9081

 [www.buildersolutionus.com](http://www.buildersolutionus.com)

 [info@buildersolutionus.com](mailto:info@buildersolutionus.com)

 1155 CAMINO DEL MAR

SUITE 423

DEL MAR



# CATALOG

<b>01</b>	<b>COMPANY INFORMATION</b> .....	<b>2</b>
	CERTIFICATIONS & TEST REPORT.....	4
<b>02</b>	<b>STEEL FIRE DOOR</b> .....	<b>6</b>
	DOUBLE STEEL FIRE DOOR.....	6
	SINGLE STEEL FIRE DOOR.....	14
	TECHNICAL INTRODUCTION.....	22
	DOOR SURFACE TREATMENT.....	30
	SPRAYING PROCESS COLOR OP IONS.....	34
	INSTALLATION GUIDE.....	38
<b>03</b>	<b>OTHER PRODUCTS</b> .....	<b>40</b>
	HOSPITAL DOOR SERIES.....	40
	SOUND-PROOF DOOR.....	46
	FIRE SHUTTER DOOR & ROLLER SHUTTERS DOOR.....	50
	EXPLOSION-PROOF DOOR & EXPLOSION RELIEF DOOR.....	52
	FIRE WINDOW & EXPLOSION-PROOF WINDOW.....	54
<b>04</b>	<b>HARDWARE PARTS</b> .....	<b>56</b>
<b>05</b>	<b>RODUCTION LINE &amp; PACKAGING</b> .....	<b>60</b>
<b>06</b>	<b>PROJECT PORTFOLIO</b> .....	<b>64</b>



# STEEL FIRE DOOR

## DOUBLE FIRE DOOR

- **Certifications:** Certified with UL/NFPA/EN/BS/GB
- **Fire rated time:** 20 mins up to 180mins
- **Double Door customized Max Size:** 9'- 5.7"\*10'-2.2"ft(height)
- Available with handle lock,panic bar and fire-proof window



SF02

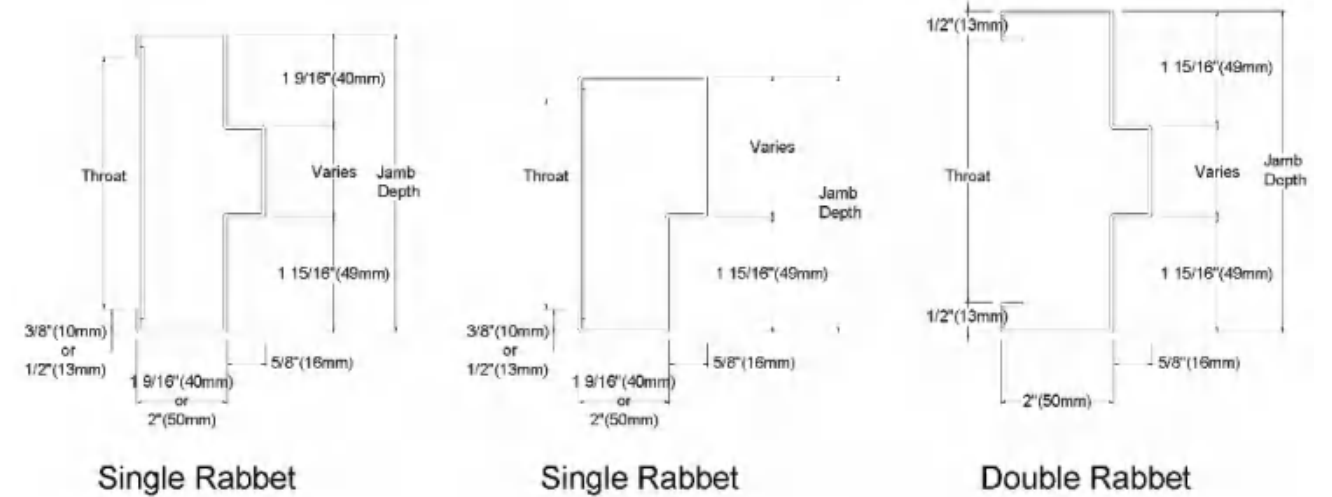
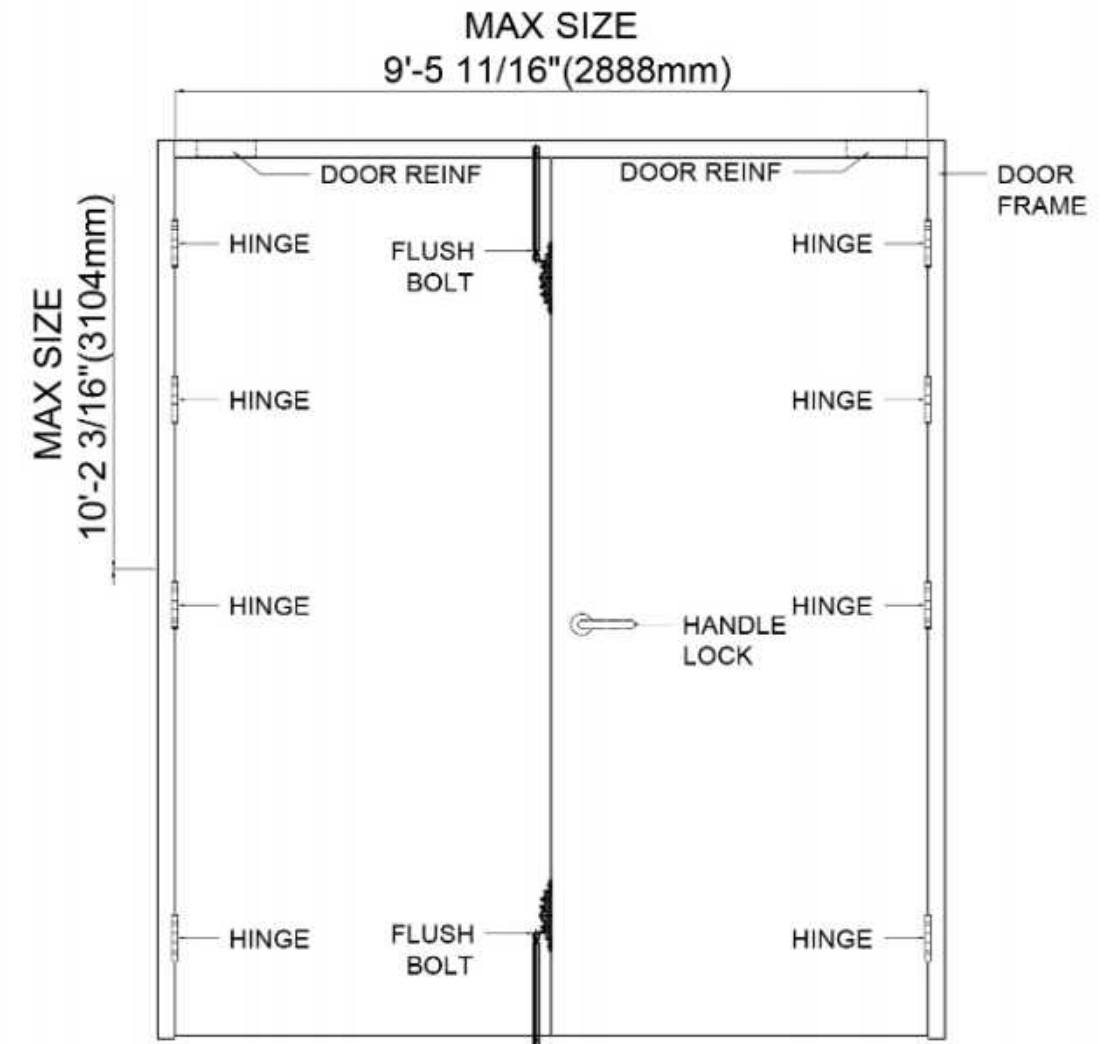

# DOOR COMPONENTS

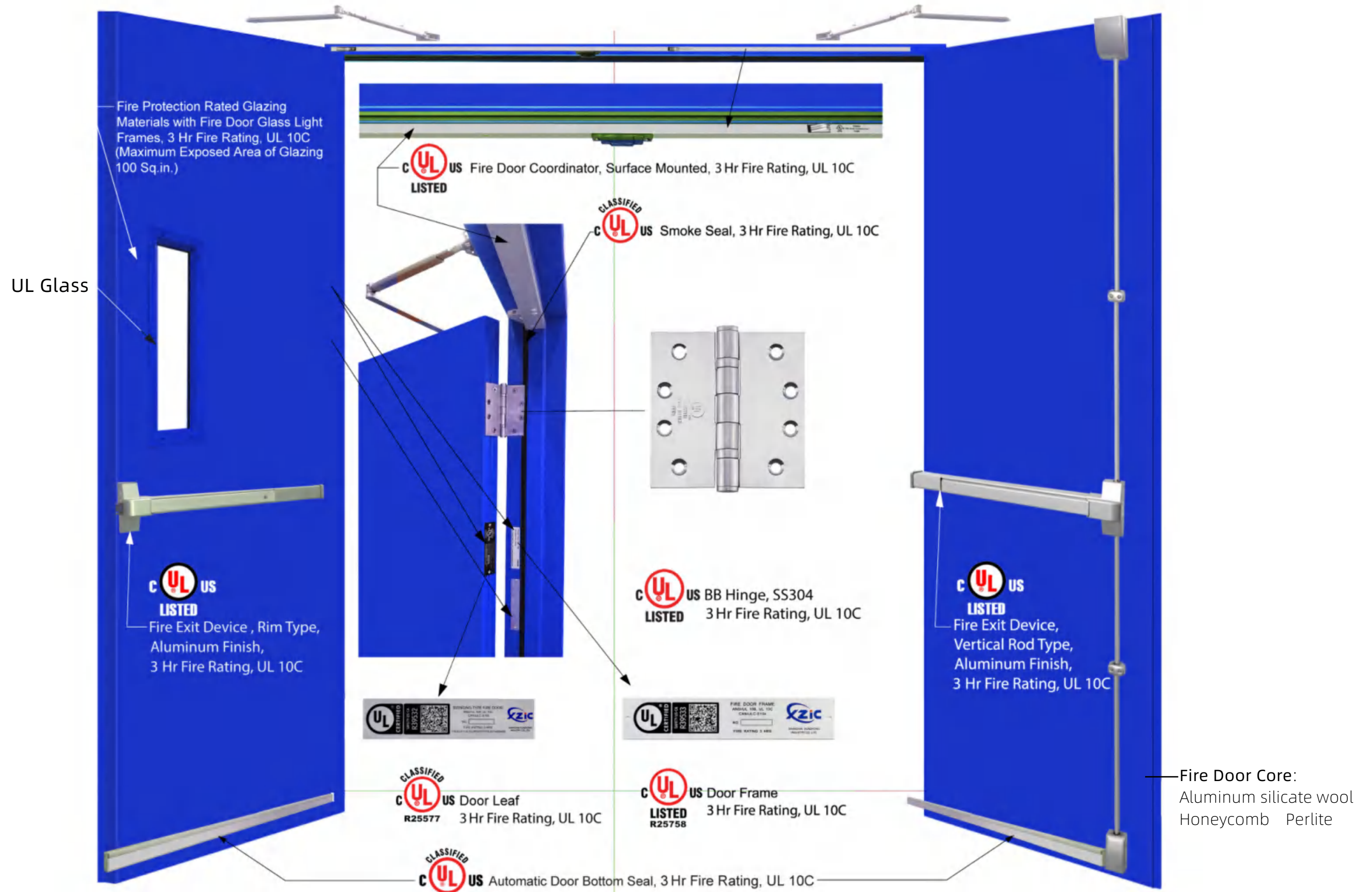

SF03

### DOOR TYPE SHOW



### DOOR APPLICATION

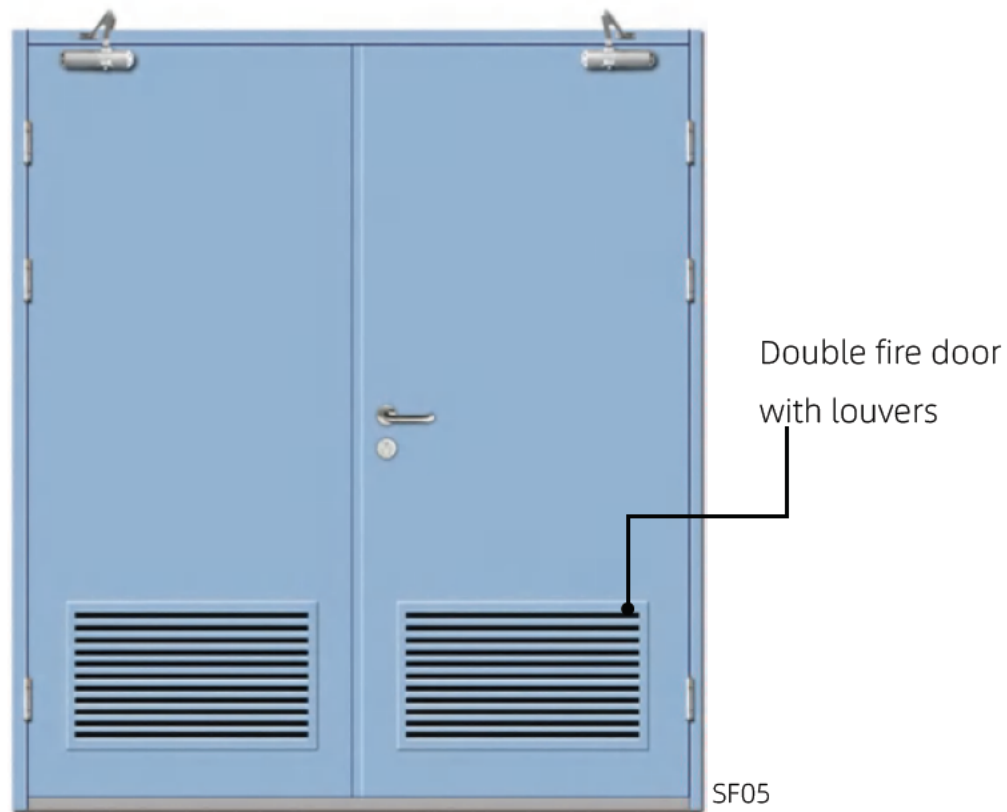





## // SINGLE FIRE DOOR

- **Certifications:** Certified with UL/NFPA/EN/BS/GB
- **Fire rated time:** 20 mins up to 180mins
- **Single Door customized Max Size:** 5' \* 10' 2.2" ft ( height )
- Available with handle lock,panic bar and fire-proof window

Steel fire doors are made of high-strength steel and serve as fire safety facilities in buildings. They possess excellent fire resistance and durability, effectively protecting people's lives and properties.

Additionally, they also offer features such as anti-theft, anti-collision, sound insulation, and thermal insulation.



SF20

## EXPLODED VIEW OF DOOR





# DOOR TYPE SHOW

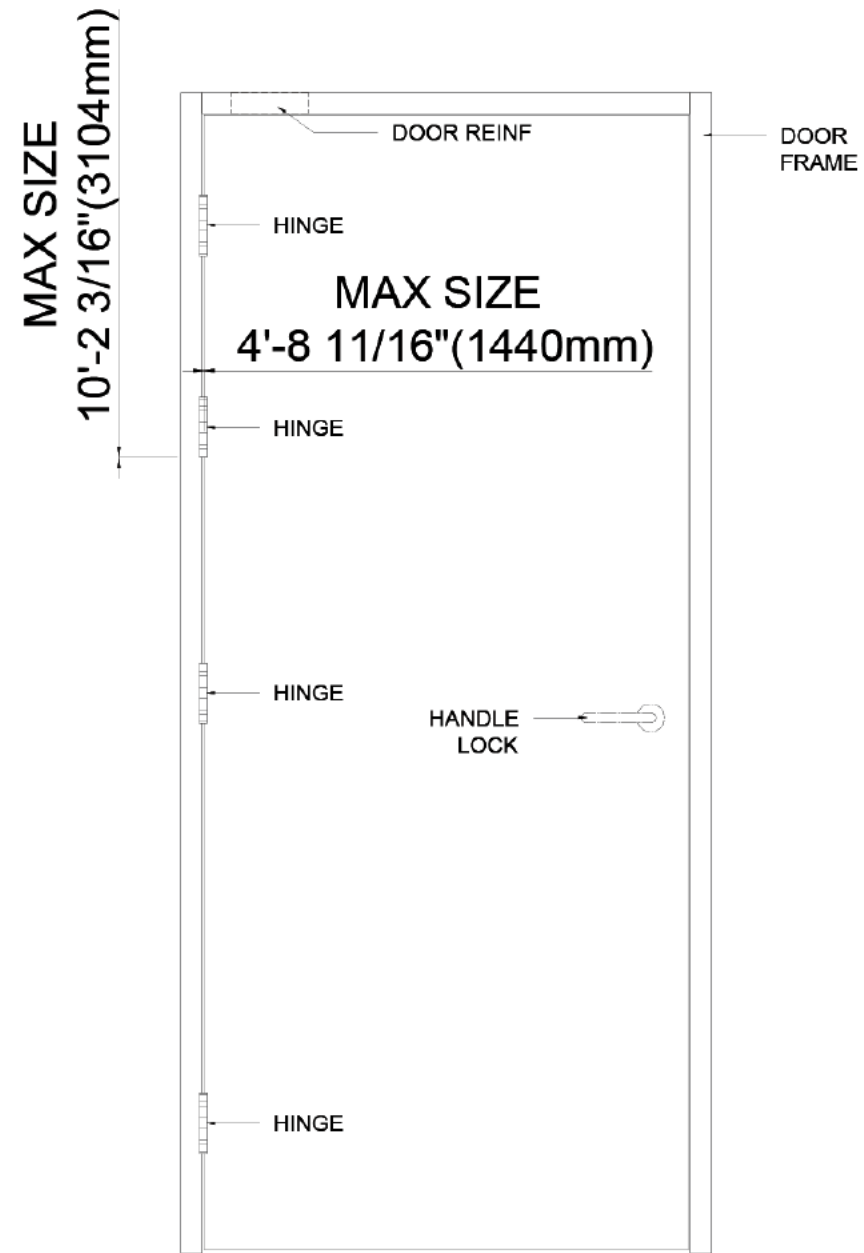

SF22



SF23



SF24



SF25



SF26



SF27

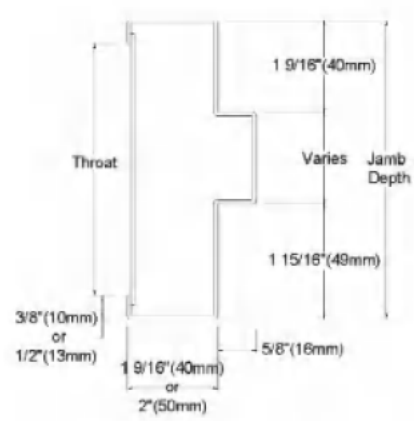

Single Rabbet

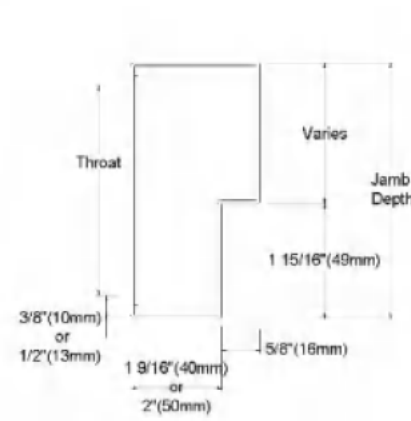

Single Rabbet

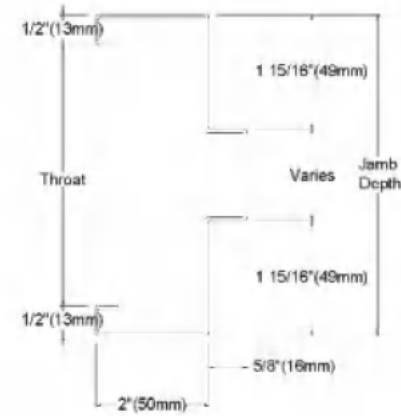

Double Rabbet

# DOOR APPLICATION



SF22

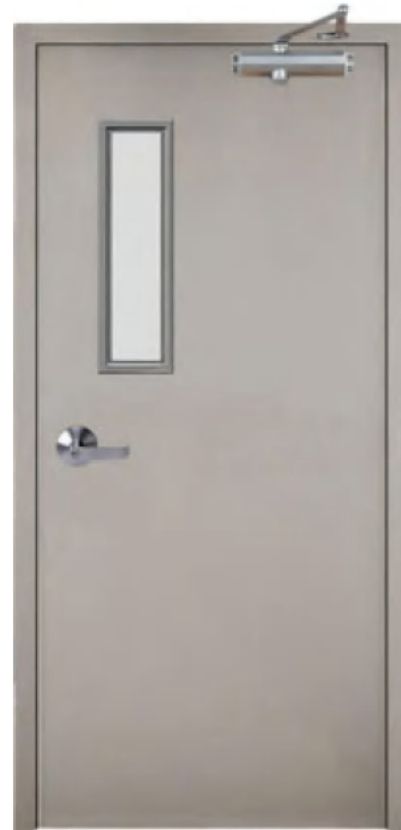

SF23



SF24



SF28



SF25



SF26



SF27



SF29



SF30



SF31



SF33



SF32



SF34



## // TECHNICAL INTRODUCTION

### FRAME

Various kinds design of frame profiles are available, suitable for different installation environment.

### HARDWARE AVAILABLE

UL/Non-UL panic bar, external level trim, door closer, hinge, flush bolt, vision glass, magnetic door holder, coordinator, smoke seal, handle lock, automatic door bottom seal etc.

### OPTION

Door and frame surface finish could be customized according to RAL color chart.

### CARVING / INLAY OPTIONS

Customized metal/wood trims inlay, profile carving, sometimes change a boring flush door design to a unique and beautiful one. Work with XZIC to get your unique design.

## STEEL DOOR SKIN

16GA(1.5mm),18GA(1.1mm),20GA(0.9mm)  
A40 Galvanized Or Cold-rolled Steel Skins  
Construction is 1-3/4 " (45mm)Thickness

Hinge,closer,lock and strike plate reinforcements shall be provided.

Hinge reinforcement:10GA(3.5mm)

Closer reinforcement:12GA(2.5mm)

Lock reinforcement:16GA(1.5mm)

Strike plate reinforcement:16GA(1.5mm)

The top,bottom and side closures are fabricated from 16GA(1.5mm) thick channel shaped steel sections welded to the front and back door skins.

Flush top channel:16GA(1.5mm)

Laser-welded side-seamed edge.

Widths up to and including 5 " ft

Heights up to and including 10 ' -2.2 " ft

Available with polystyrene core, honeycomb core or Perlite

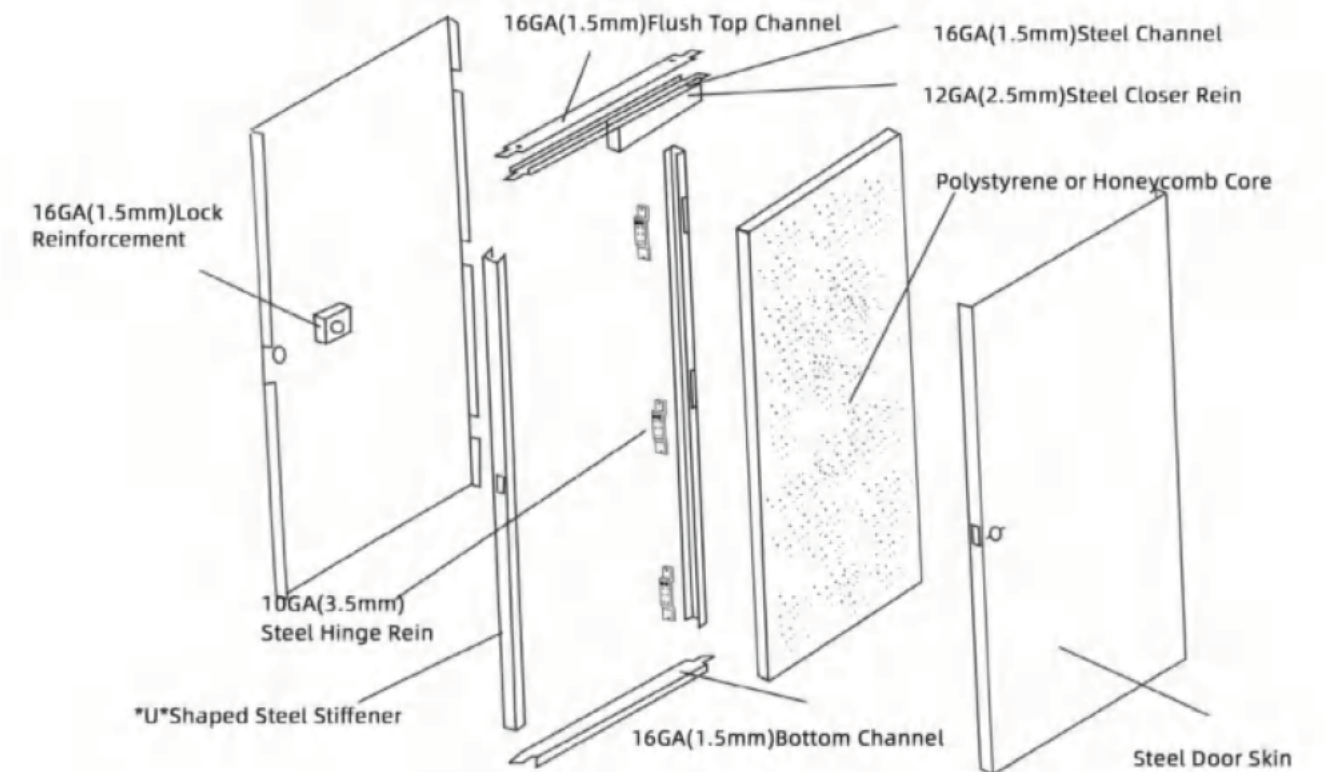

# TYPICAL STEEL FRAME DESIGN

Double Rabbet



Single Rabbet



Cased Open



Double Egress



Typical Wall Construction

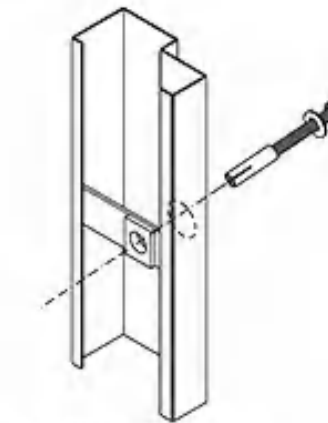

Expansion-Shell Anchor (Standard)

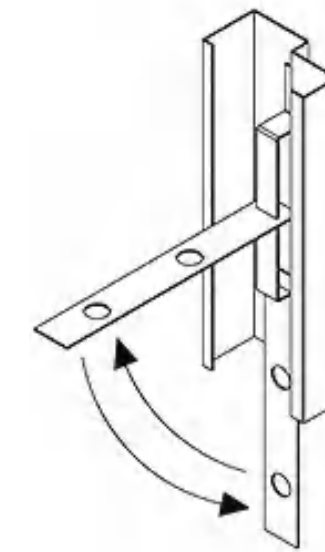

Adjustable Masonry Anchor (Optional, on request only)

Double Rabbet



Butted



Typical Sill And Wall Anchors

Wire



T



Stud



Sill anchor



Typical Sill And Wall Anchors

Pressure anchor



Sill anchor (loose)

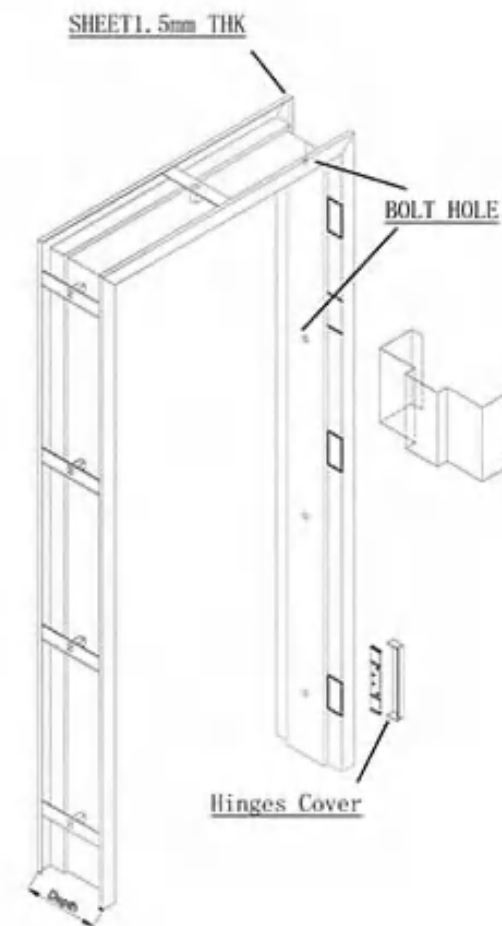

Door frame





### MASONRY/STUD CONSTRUCTION FRAME

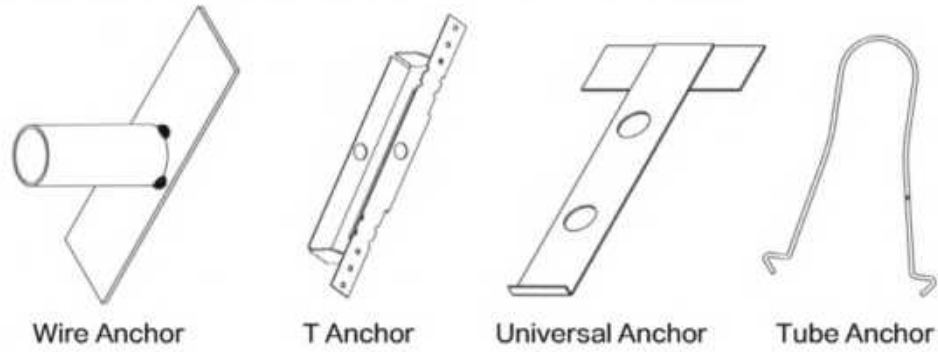

Jamb Depth	4-3/4"	5-3/4"	6-1/4"	6-3/4"	7-1/4"	7-3/4"	8-1/4"	8-3/4"	9-1/4"	10-1/4"
Throat Opening	3-3/4"	4-7/8"	5-1/4"	5-3/4"	6-1/4"	6-3/4"	7-1/4"	7-3/4"	8-1/4"	9-1/4"

### DRYWALL FRAME

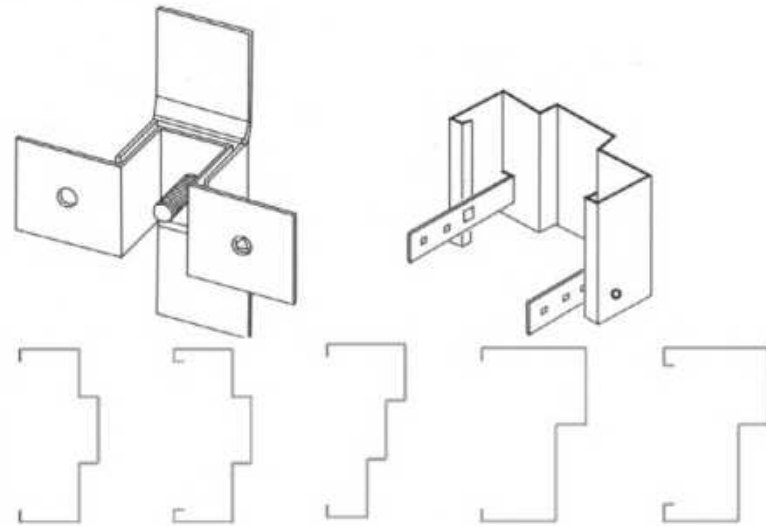

Jamb Depth	4
Throat Opening	3

### Frame Profiles

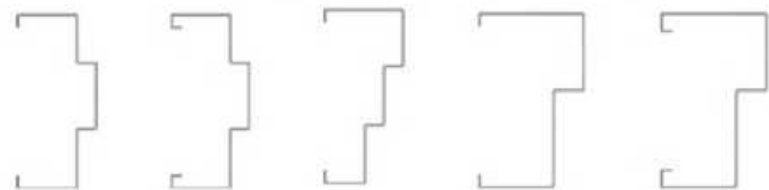

xunzhong steel fire doors conform or exceed SDI/HMMA industrial standards, fire tested and certified with UL, Intertek/WH from 20Min up to 3hrs fire rating, complying criteria as UBC7-2, ANSI/UL10C UL10B CAN/ULC-S104

### OPEN DIRECTION INDICATOR

The direction of opening the door can be based on customer need

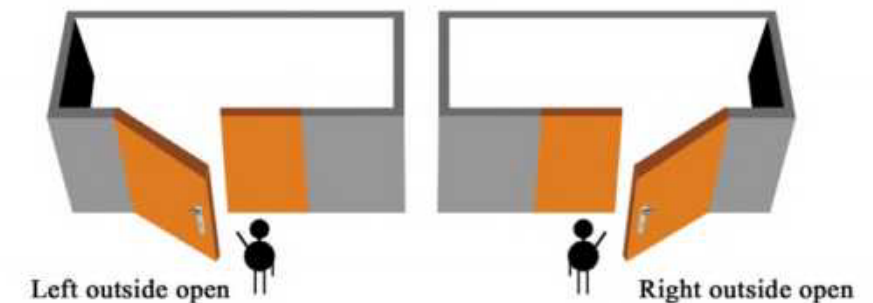
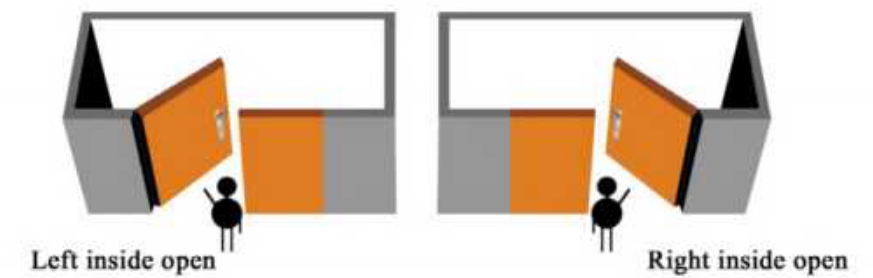
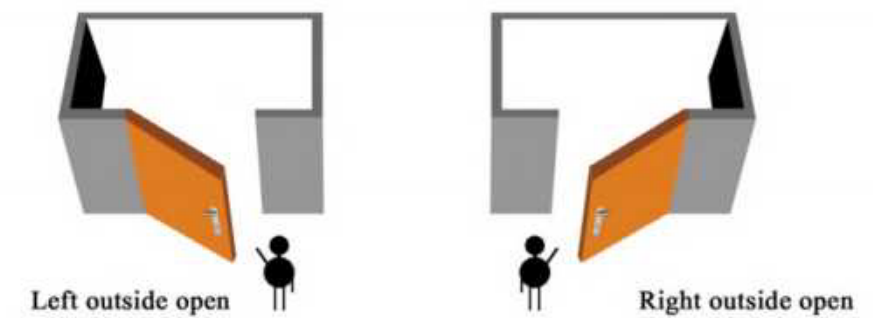

# EMBOSSED PANELS

Another easy way to make your door look great is with embossed panels. This is a cost-effective metal version of Stile and

Rail wood doors that bring a traditional and elegant look to your door. With up to 8 panels, you have variety of options to find the right look for your aesthetic.

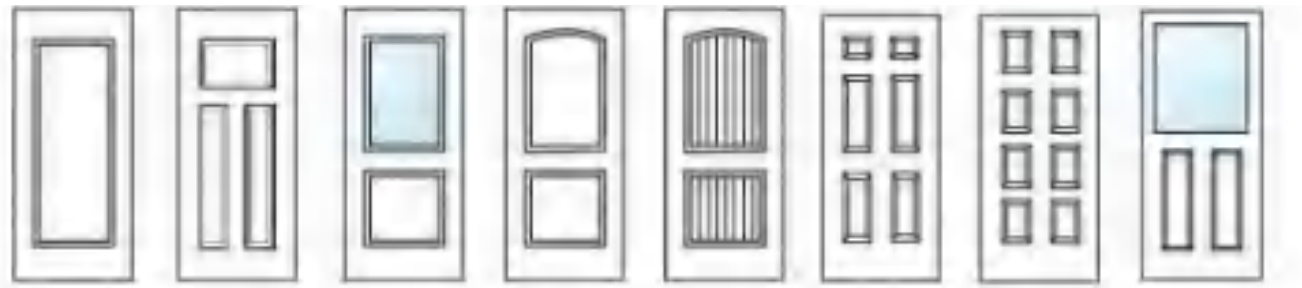

Flush

Vision Lite

Louvered



wo Panel

Four Panel

Six Panel

## // DOOR SURFACE TREATMENT

### WOOD GRAIN TRANSFER

Wood grain transfer is a process of applying a wood grain pattern onto a surface, typically used for non-wood materials, to create the appearance of real wood.

After the transfer process, the surface will have the appearance of real wood, with the texture and wood grain pattern imprinted onto it, providing a wide range of design possibilities.



SF50



SF51



SF52



# COLOR OPTIONS



4k9058-3



4k9035-5

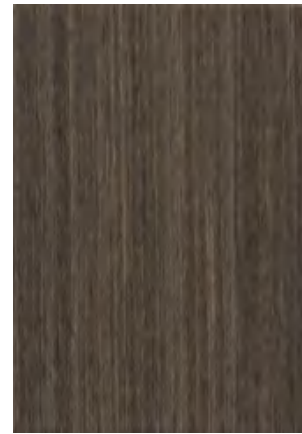

ps1583

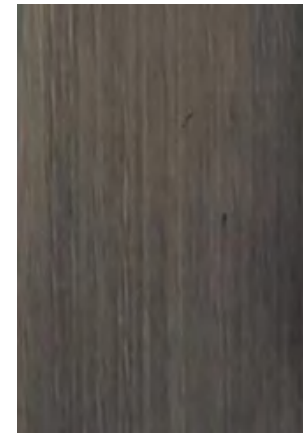

wt01



wt02

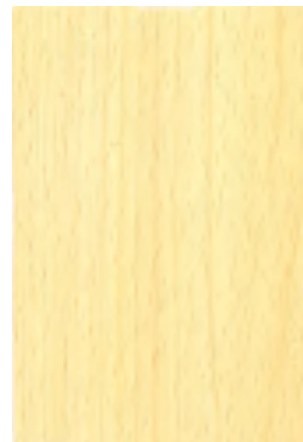

wt03



wt04



wt05



wt06



wt07



wt08



wt09



SF53



SF54



SF55

\* XZIC offers customized color options, and don't hesitate to contact our sales representatives for more information.

# SPRAYING PROCESS COLOR OPTIONS

In addition, we provide customization services to create unique colors based on our customers' specific requirements. Whatever color you need, we can meet your needs and provide personalized color schemes for your products.

RAL 1000	RAL 1013	RAL 1034
RAL 1001	RAL 1014	RAL 1035
RAL 1002	RAL 1015	RAL 1036
RAL 1003	RAL 1016	RAL 1037
<small>Signalfarbe für Warnung, Verkehr, Hinweis (DIN 4544)</small> RAL 1004	RAL 1017	RAL 2000
RAL 1005	RAL 1018	RAL 2001
RAL 1006	RAL 1019	RAL 2002
<small>Signalfarbe für Warnung vor Gefahren und Hindernissen (DIN 4544) ehemals Chromgelb</small> RAL 1007	RAL 1020	<small>Farbfolge für Durchlauf von Säuren (DIN 2403)</small> RAL 2003
<small>verwendet für Rettungswagen</small> RAL 1011	<small>Farbfolge für Durchlauf trennbarer Flüssigkeiten (DIN 2403) ehemals Kaliumgelb</small> RAL 1021	RAL 2004
RAL 1012	RAL 1023	RAL 2008
RAL 1033	RAL 1024	RAL 2009
RAL 9010	RAL 1027	RAL 2010
RAL 9007	<small>auch als Luftdruck-Gelb bezeichnet</small> RAL 1028	RAL 2011
RAL 7005	RAL 1032	RAL 2012

RAL 7006	RAL 7031	RAL 8000
RAL 7008	RAL 7032	<small>Kennfarbe für Durchfluss trennbarer Flüssigkeiten (DIN 2403)</small> RAL 8001
RAL 7009	RAL 7033	RAL 8002
RAL 7010	RAL 7034	RAL 8003
RAL 7011	RAL 7035	RAL 8004
RAL 7012	RAL 7036	RAL 8007
RAL 7013	RAL 7037	RAL 8008
RAL 7015	RAL 7038	RAL 8011
RAL 7016	RAL 7039	RAL 8012
RAL 7021	RAL 7040	RAL 8014
RAL 7022	RAL 7042	RAL 8015
RAL 7023	RAL 7043	RAL 8016
RAL 7024	RAL 7044	RAL 8017
RAL 7026	RAL 7045	RAL 8019
RAL 7030	RAL 7046	RAL 8022
RAL 9001	RAL 9016	RAL 8023
RAL 9002	RAL 9017	RAL 8024
RAL 9003	RAL 9018	RAL 8025
RAL 9004	RAL 9021	RAL 8027
RAL 9005	RAL 9022	RAL 8028
RAL 9006	RAL 9023	RAL 8029



RAL 5003	RAL 5000	RAL 6004
RAL 5004	RAL 5001	RAL 6005
RAL 5005	<small>Signalfarbe für Hinweise, Schutzpflicht (DIN 4844)</small> RAL 5002	RAL 6006
RAL 5007	RAL 5025	RAL 6007
RAL 5008	RAL 5026	RAL 6008
RAL 6027	<small>Signalfarbe für Erste Hilfe, Notausgang (DIN 4844)</small> RAL 6002	RAL 6009
RAL 5009	RAL 6003	RAL 6010
<small>Signalfarbe für (unterrichtendes) Gebot (DIN 4844)</small> RAL 5010	RAL 6012	<small>verwendet für Maschinen</small> RAL 6011
RAL 5011	RAL 6013	RAL 6028
RAL 5012	RAL 6014	RAL 6029
<small>auch als Lufthansa-Blau bezeichnet</small> RAL 5013	RAL 6015	RAL 6031
RAL 5014	RAL 6016	RAL 6032
<small>Kennfarbe für Durchfluss von Sauerstoff (DIN 2403)</small> RAL 5015	RAL 6017	RAL 6033
RAL 5017	<small>Kennfarbe für Durchfluss von Wasser (DIN 2403)</small> RAL 6018	RAL 6034
RAL 5018	RAL 6019	RAL 6035
RAL 5019	RAL 6020	RAL 6036
RAL 5020	RAL 6021	RAL 7000
RAL 5021	RAL 6022	<small>Kennfarbe für Durchfluss von Luft (EN 2403)</small> RAL 7001
RAL 5022	RAL 6024	RAL 7002
RAL 5023	RAL 6025	RAL 7003
RAL 5024	RAL 6026	RAL 7004

RAL 2013	RAL 3016	RAL 4006
<small>Kennfarbe für Durchfluss von Dampf (DIN 2403) Signalfarbe für Verbot, Halt, Notaus (DIN 4844)</small> RAL 3000	RAL 3017	RAL 4007
RAL 3001	RAL 3018	RAL 4008
<small>Signalfarbe für Brandbekämpfung (DIN 4844)</small> RAL 3002	RAL 3020	RAL 4009
RAL 3003	RAL 3022	RAL 4010
RAL 3004	RAL 3027	RAL 4011
RAL 3005	RAL 3031	RAL 9011
RAL 3007	RAL 3032	RAL 3014
RAL 3009	RAL 3033	RAL 3015
RAL 3011	<small>Kennfarbe für Durchfluss von Laugen (DIN 2403)</small> RAL 4001	RAL 4004
RAL 3012	RAL 4002	RAL 4005
	RAL 4003	RAL 3013

\* Due to variations in monitors, there may be slight color variations in the actual colors. When viewing our color chart on electronic devices, please be aware that colors may be influenced by screen brightness, contrast, and color settings.

## // INSTALLATION GUIDE

For proper installation, consult our customer manager for detailed guidance. Here's a summary of the installation process:

### A. Pre-Installation:

1. Clear door opening of debris.
2. Verify level and square door frame.
3. Double-check door dimensions for fit.

### B. Door Alignment and Positioning:

1. Place door in opening, centering it vertically and horizontally.
2. Use shims if needed for alignment.

### C. Fastening the Door:

1. Secure door to frame using suitable screws or anchors.



2. Allow for necessary adjustments.

### D. Hinge Installation:

Mark hinge locations on door frame and door.

Install hinges with proper alignment and secure attachment.

### E. Lockset Installation:

1. Measure and mark lockset location on the door.
2. Follow manufacturer's instructions to install lockset components.

### F. Finishing touches:

1. Test door operation for smooth movement.
2. Adjust door and hardware as needed.
3. Apply touch-up paint to cover any marks or scratches.

For specific requirements, please contact our customer manager for detailed personalized installation guide.





# OTHER PRODUCTS

## HOSPITAL DOOR SERIES

Medical doors are equipped with unique features and characteristics to meet the specific needs and requirements of healthcare environments, ensuring safety, hygiene, and convenience.

**Hygiene Performance:** Medical doors are typically made of easy-to-clean and antimicrobial materials to maintain a sanitary environment. These doors have smooth surfaces that are non-absorbent and easy to disinfect, effectively preventing the spread of bacteria, viruses, and other pathogens.

**Fire Protection:** Medical doors often have certain fire resistance capabilities, acting as a barrier in case of a fire incident, protecting the safety of personnel and equipment.



SF62



SF63



SF60



SF61



SF64



SF65

## DOOR APPLICATION



**Sound Isolation:** Medical doors can provide excellent sound isolation, preventing the transmission of noise and maintaining a quiet and private healthcare environment.

**Safety Control:** Medical doors are often equipped with safety control systems such as fingerprint recognition, card access control, etc., to restrict access by unauthorized individuals, ensuring the security and confidentiality of medical facilities.

**Easy Passage:** Medical doors are designed for ease of use and convenient passage, with features such as automatic opening, foot-activated switches, or doors equipped with accessibility features.





SF69



SF71



SF70

Medical doors play a vital role in healthcare environments, providing secure, hygienic, and convenient access solutions. They can be customized to meet different medical needs and environmental requirements, catering to various applications and scenarios.



SF72



## SOUND-PROOF DOOR

Soundproof doors are specially designed doors that have the following features and advantages:

Excellent soundproofing performance: they are built with sound-absorbing materials and sealed design to effectively reduce noise transmission and minimize disturbances.

Multilayer structure: Soundproof doors consist of multiple layers of materials such as solid wood, steel plates, and sound insulation fillings, providing superior soundproofing capabilities.



SF80

## WOOD SOUND-PROOF DOOR



SF81

SF82

SF83



SF84

SF85

SF86

## STEEL SOUND-PROOF DOOR



**Strong sealing performance:** With small gaps and tight seals, they prevent sound from passing through the door, enhancing the soundproofing effectiveness.

**High strength and security:** Soundproof doors are made of sturdy materials and designed with durable structures, ensuring both strength and security to protect the premises.

**Versatile appearance and styles:** They come in a variety of designs and styles to suit different interior designs and decorations.

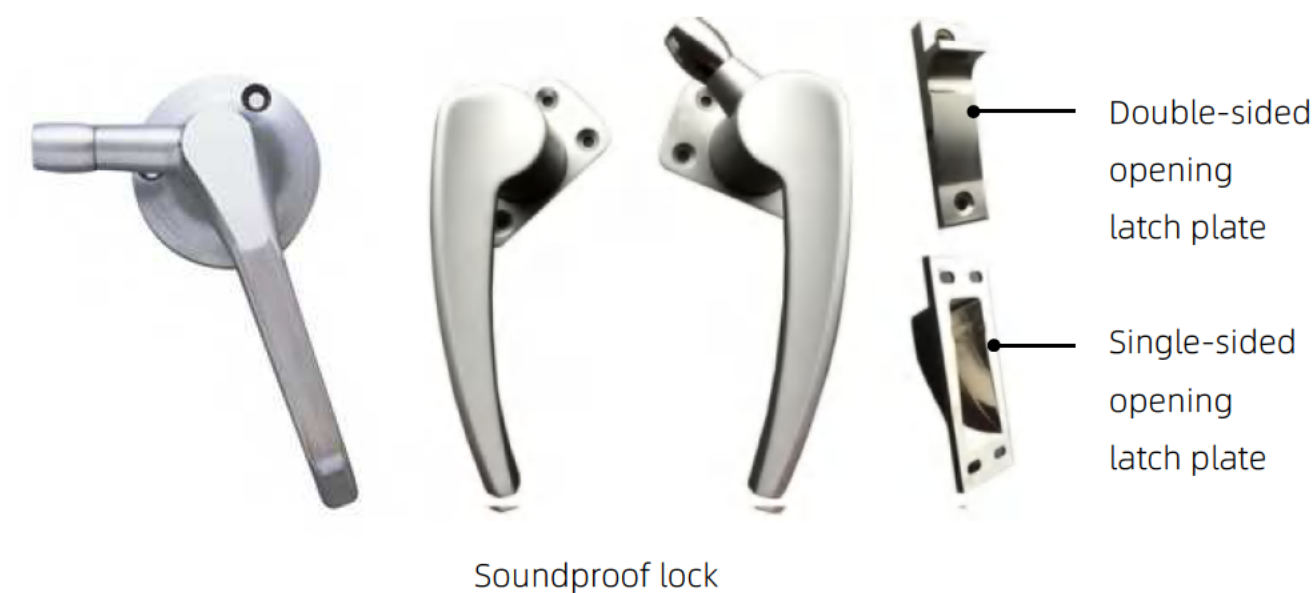



## FIRE SHUTTER DOOR & ROLLER SHUTTERS DOOR

### FIRE SHUTTER DOOR



SD01



SD02

### ROLLER SHUTTERS DOOR



SD03



SD04



**EXPLOSION-PROOF DOOR &  
EXPLOSION RELIEF DOOR**

**EXPLOSION-PROOF DOOR**



**EXPLOSION RELIEF DOOR**



## FIRE WINDOW & EXPLOSION-PROOF WINDOW

### FIRE WINDOW



SD09



SD10

### EXPLOSION-PROOF WINDOW

Our bulletproof windows are made with high-quality special materials and advanced manufacturing techniques, providing excellent resistance to impact and explosions.

We offer a variety of specifications and models of bulletproof windows to meet the diverse needs of our customers. Whether it is for government institutions, military facilities, or commercial buildings, we can provide you with high-quality bulletproof windows to protect the safety of your personnel and property.



SD11



SD12



# HARDWARE PARTS



Handle 1



Handle 2



Handle 3



Handle 4



Mortise Lock 1



Mortise Lock 2



Cylinder 1



Cylinder 2



Cylindrical lock 1



Cylindrical lock 2



Mortise Lock 1



Mortise Lock 2



Mortise lock 3



Viewer



Butt Hinge 1



Spring Hinge 2



Smart Lock 1



Smart Lock 2



Smart Lock 3



Smart Lock 4



Closer 1



Closer 2



Closer 3



Closer 4



Lever trim 1



Lever trim 2



Lever trim 3



Concealed hinge



Bottom seal



Magnetic door holder



Pull & push



Push Bar 1



Coordinator 1



Coordinator 2



Flush bolt



# HARDWARE PARTS



Push Bar 2

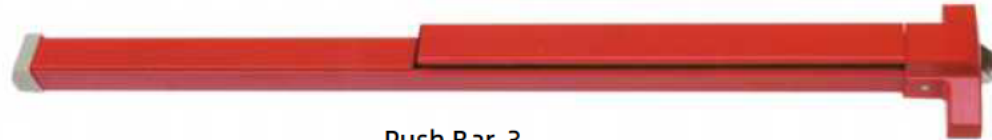

Push Bar 3



Push Bar 4



Push Bar 5



Push Bar 6



Threshold Plate RP28

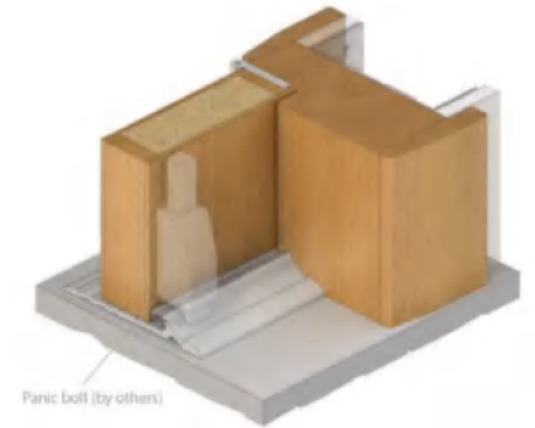

Threshold Plate Seal RP117Si



Panic bolt (by others)

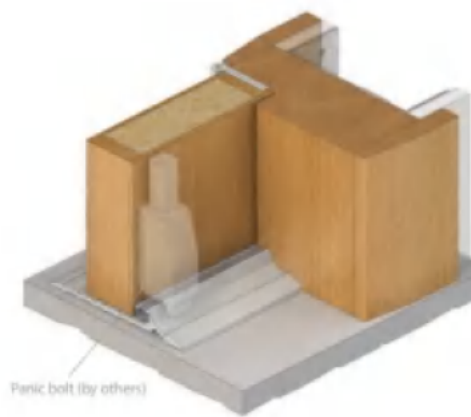

Threshold Plate Seal RP700



Brush Strip Seal RP129



Perimeter Seal RP70Si



half round door stop



Water Drop Seal RP700



anti kick plate

# PRODUCTION LINE & PACKAGING

such as automatic sheet metal break machine, CNC machine, painting & coating line.





# PACKAGING

Moisture-proof, dust-proof and shock-proof package meets requirements of long-distance transport and open storage.



Packing on a pallet



Load the door into the container with a forklift



Packed and packed into containers (Length: 12 meters)

Package for the products: Plastic foam+Bubble wrap +Strong carton(optional).

