

RSF Trading Innovation & Builder Solutions

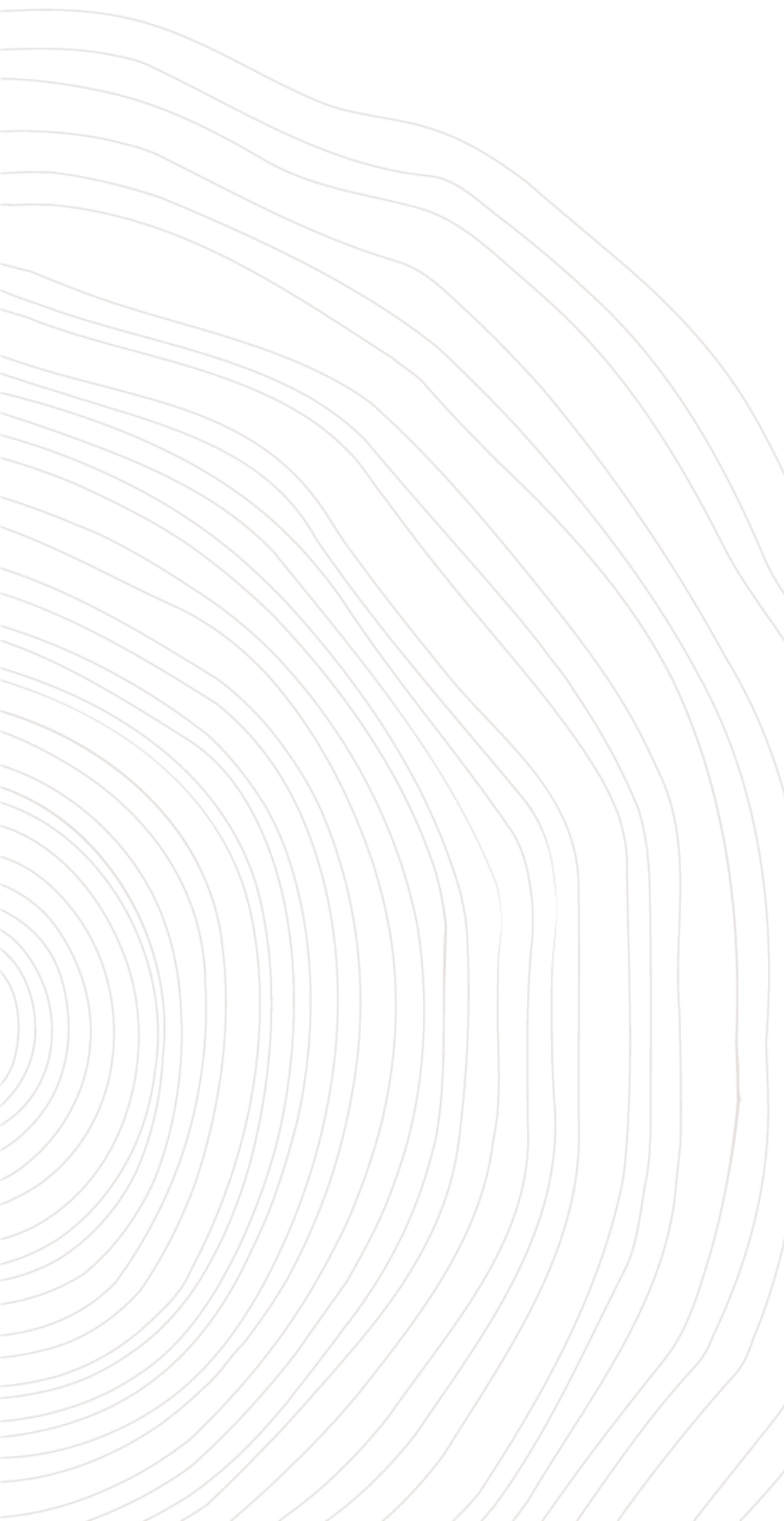

DOORS CATALOG

DOOR COLLECTIONS



FSII	04	
PREMIUM PAINTED DOOR	06	
PAINTED DOOR	08	
PREHUNG DOOR	11	
MOLDED DOOR	12	
SHAKER DOOR	14	
PRE-FINISHED DOOR	16	
BARN DOOR	22	
FOLDING DOOR	24	
POCKET DOOR	26	
WPC DOOR	30	
FIBERGLASS DOORS	32	
ACCESSORY COLLECTION	34	

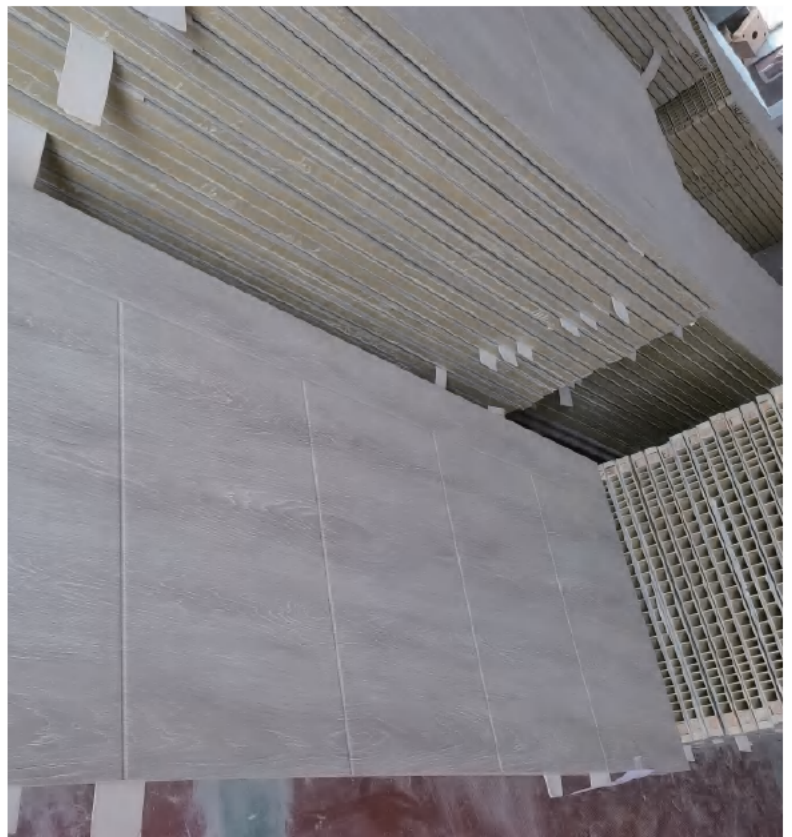



PREMIUM PAINTED DOOR

SETS INCLUDING



CROSEHEAD

Elevate your space with our premium wooden crossheads. Designed to add a touch of sophistication to any doorway or window, these elegant features are the perfect blend of tradition and style, making every entrance a statement.

DOOR SLAB

Transform your entryway with our exquisite wooden door slabs. Crafted for both beauty and durability, these slabs offer a timeless appeal, customizable to fit your unique aesthetic. Make a lasting impression with every knock..



FRAME & CASING

Complete your door with our luxurious wooden frames and casings. Expertly designed to not just support, but also to enhance the look of your doors, these elements are the finishing touches that frame your doorways in elegance and style.

BASEBOARD

Accentuate your interiors with our elegant wooden baseboards. These stylish yet functional trims are the perfect way to add a polished finish to your rooms, seamlessly blending protection with unparalleled aesthetic charm.



PAINTED DOOR

CLASSICAL | TRADITIONAL | MODERN

Elegant Natural Wood Shiplap

Discover the charm of our Natural Wood Shiplap, a true portrayal of organic elegance. Each piece meticulously showcases the wood's inherent grain texture, brought to life through our refined brush finishing technique. This process highlights the natural beauty and intricate patterns of the wood, creating a visually stunning effect.

Durability and Outdoor Appeal

With the option of a thermally modified treatment, our shiplap panels offer more than just beauty. They are robust and built to endure harsh outdoor elements, making them a perfect choice for exterior spaces. Dive into the realm of natural allure with our shiplap, and let its intricate details and organic beauty create a harmonious and inviting atmosphere in any outdoor setting.



Width	18"	20"	24"	28"	30"	32"	34"	36"
Height	78"	80"	84"	88"	90"	92"	94"	96"

Select your ideal style We'll handle everything else!



Our method starts with a meticulously inspected, dust-free, unfinished door. We then apply multiple coats of paint, baking each layer to ensure durability and beauty. The outcome is a finish that's as long-lasting as it is attractive.



Field finishing a door can consume significant time and effort. Allow us to do the demanding work. Just select your desired paint color, and we'll handle everything from there.



Explore endless possibilities with our vast array of modern paint colors and stains readily available for your selection.



PAINT COLORS Available on primed and moulded doors

Our precise meticulous process ensures exceptional quality and saves you valuable time and money.

FEDERAL STANDARD

Insignia White 37925	White 27925	Lime Yellow 13670	Orange Yellow 13538	Yellow 23655	Tan 20260	Insignia Red 11136	Red 21105
Orange 32473	Sand 32648	Ochre 33434	Yellow Sanc 33695	Radome Tan 33613	Dark Yellow 33448	Forest Green 34079	USMC Green 34052
Dark Blue 35109	Medium Blue 35177	Blue Gray 35189	Azure Blue 35231	Light Blue 35622	Dark Gray 36099	Gray 36152	Sky Gray 36473
Olive Drab 34088	Green 34666	Sky 34554	Light Green 34552	Tan Green 34201	Deep Green 34128	Olive Drab 14087	Black 37038



PRIMED INTERIOR DOOR

INTERIOR DOORS

PREHUNG DOOR

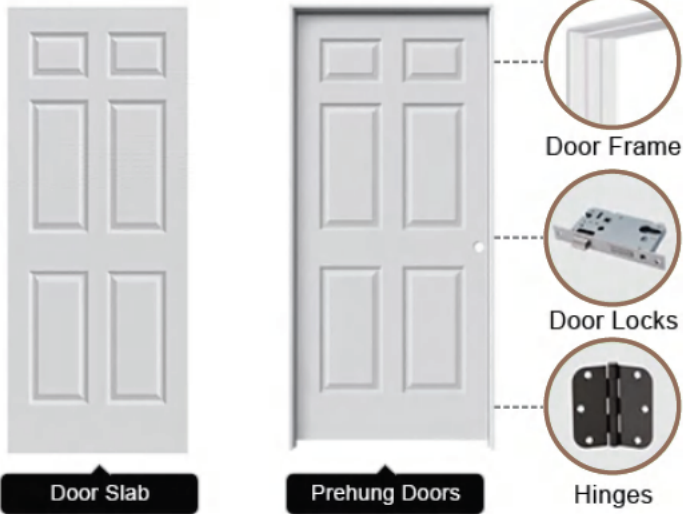

A "prehung door" is a complete door unit that includes the door, frame, hinges, doorknob, and often a lockset. It comes preassembled and is ready for installation, simplifying the process.

- ▶ Convenient Installation
- ▶ Precision Fit
- ▶ Quality Assurance
- ▶ Consistency



PRIMER DOOR MATERIAL STRUCTURE

ASK FOR WHAT YOU NEED AND WE'LL TAKE CARE OF IT

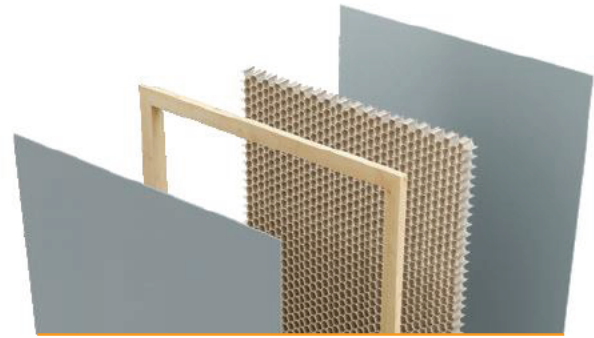

Honeycomb (standard solution)



XPS



Tubular Chipboard | Particules Tubulaires



Full Chipboard | Particules Solides

MOLDED DOOR

CLASSICAL | TRADITIONAL | MODERN



Elevate Your Home's Aesthetic

Discover the epitome of elegant living with our Primer Molded Doors. Meticulously crafted and primed, these doors are ready to enhance your home's visual appeal. The sleek, smooth finish provides a versatile base for your individual style expressions.

Durability and Beauty in Harmony

Choose our doors for a harmonious blend of durability and beauty. Make every entrance a grand one with these expertly crafted and primed doors, offering both style and substance to your living space.



Lincoln Park 1 Panel



Logan 2 Panel



Winslow 3 Panel



2 Panel



4 Panel



6 Panel

Width	18"	20"	24"	28"	30"	32"	34"	36"
Height	78"	80"	84"	88"	90"	92"	94"	96"

RSF Trading Innovation & Builder Solutions



Flush



Berkley 5 Panel Horizontal



Cheyenne 2 Panel



Full Lite



10 Lite



2 Panel Arch-Top



3 Panel

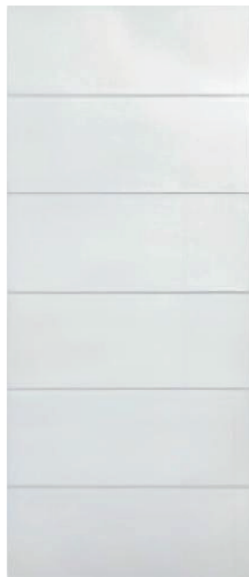

Melrose

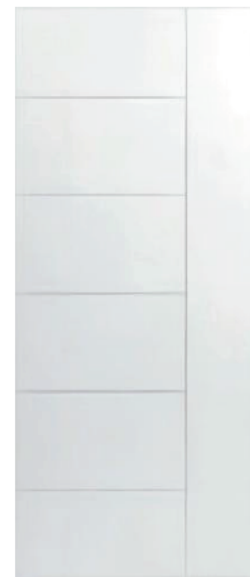

Berkley



Riverside



SHAKER DOOR

CLASSICAL | TRADITIONAL | MODERN

Have Shaker doors left a lasting impression on both residential and light commercial construction? From my perspective, the answer is a resounding yes.

Dependable Performance

Can you believe that Shaker doors resist cracking and panel separation, even when faced with seasonal humidity changes? It's impressive how they maintain their structural integrity over time.

Unmatched Value

What sets Shaker doors apart is their remarkable value proposition. They offer captivating design choices and extensive customization opportunities, all at a significantly lower cost compared to solid wood doors. For budget-conscious projects, Shaker doors are an absolute winner, ensuring that style and quality aren't compromised.





Shaker door Craftsmanship: Timeless Simplicity

Shaker craftsmanship places a strong emphasis on handcrafting techniques and meticulous attention to detail. Craftsmen often utilize traditional woodworking methods like dovetail and mortise-and-tenon joinery to ensure high-quality craftsmanship. This approach results in durable and long-lasting products that stand the test of time. Shaker craftsmanship is a testament to the beauty of simplicity and functionality in woodworking.

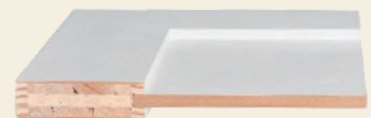

L-Series

- Crisp, clean lines
- True shadow lines
- Square profiles
- Shaker panel design

Width	18"	20"	24"	28"	30"	32"	34"	36"
Height	78"	80"	84"	88"	90"	92"	94"	96"



PRE-FINISHED DOOR

VENEER OPTIONS



Melamine

Selecting melamine for painted doors offers durability, scratch and stain resistance, color variety, water resistance, eco-friendliness, and safety features.



PVC

PVC-coated doors resist scratches, wear, and moisture, making them suitable for various environments. Consider your specific needs and decor style when selecting high-quality PVC doors.



Hardwood

Choosing hardwood for painted doors offers natural beauty, durability, reparability, sound insulation, customization, and potential property value increase.

PANEL OPTIONS

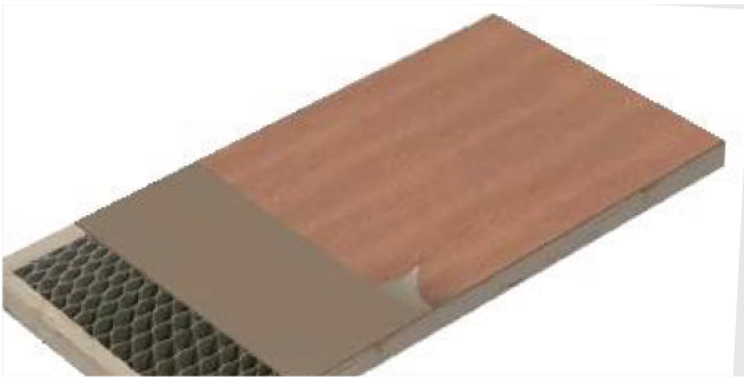

MDF

MDF (Medium Density Fiberboard) doors offer a cost-effective and eco-friendly solution with a smooth, easy-to-decorate surface. They are durable, warp-resistant, and provide good sound insulation, ideal for both residential and commercial use. Easy to maintain, MDF doors are a practical choice for those seeking value and aesthetics.

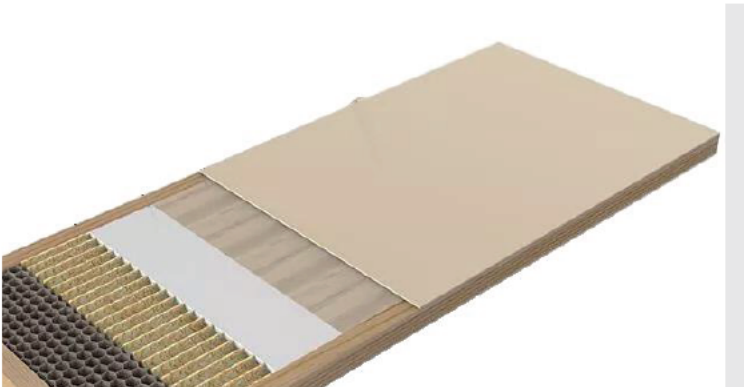

WPC

WPC (Wood Plastic Composite) door panels combine the durability of plastic with the aesthetics of wood, offering moisture and decay resistance, low maintenance, and a stylish appearance. Ideal for both practicality and visual appeal, they're a sustainable, cost-effective choice.

COLOR MATCHING

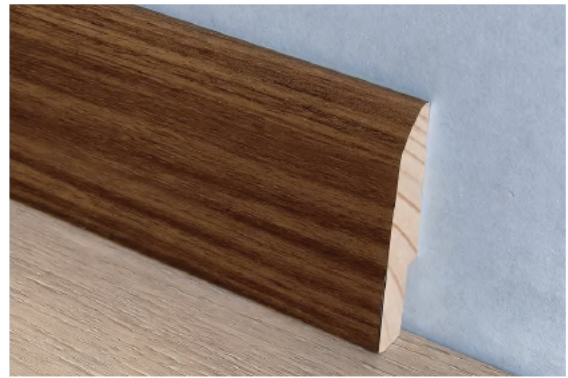

Baseboard

Baseboard is a molding or trim installed at the bottom of interior walls, serving both decorative and protective purposes by enhancing the room's appearance and shielding the wall from potential damage.

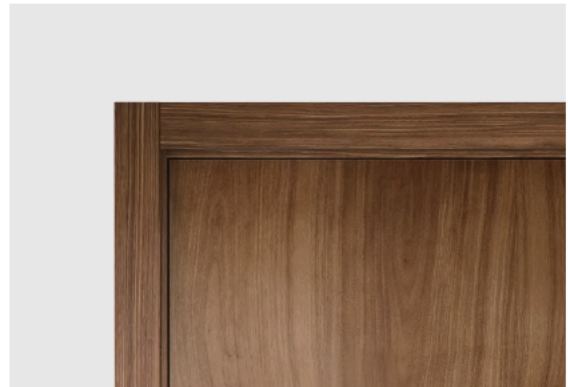

Frame & Casing

Door frames enhance room aesthetics protect walls and allow customization to match interior decor.

PRE-FINISHED DOOR

PAINT FREE | WOOD GRAIN | GORGEOUS

Effortless Elegance with Prefinished Doors

No-Paint Convenience: Discover convenience and style with our prefinished doors. These doors arrive fully treated and ready for installation, eliminating the need for additional painting and ensuring a hassle-free experience.

Versatile Finishes:

Whether you prefer the modern and sleek appeal of our lacquered finishes or a more classic look, we offer a range of options to suit every taste. Transform your spaces effortlessly with our durable, elegant, and maintenance-free doors, allowing your home to reflect your unique style and values. Enjoy the perfect blend of convenience and aesthetics with our prefinished doors.



Width	18"	20"	24"	28"	30"	32"	34"	36"
Height	78"	80"	84"	88"	90"	92"	94"	96"





SPECIALTY INTERIOR DOORS



BARN DOOR

Our Barn Door Collection is perfect for modern, contemporary, and rustic applications. Each door is meticulously crafted with superior quality, offering panel or flat panel shaker designs to suit your style. Explore the versatility of the Barn Door Collection today.



FOLDING DOOR

Similar to our Barn Door Collection, our Folding Doors effortlessly complement modern, contemporary, and rustic spaces. Crafted with superior craftsmanship, each folding door comes with panel or flat panel shaker designs to suit your style. Discover the versatility of Folding Doors today.

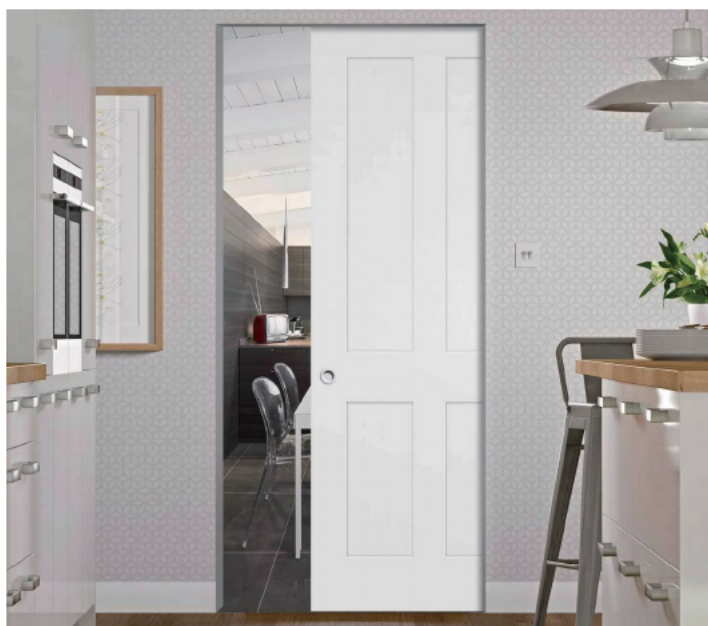

POCKET DOOR

Pocket doors are a space-efficient solution that slides horizontally into a wall, making them perfect for maximizing space in tight areas. They vanish from view when fully open, creating a seamless room transition.

BARN DOOR

These doors are distinguished by their exclusive use of solid woods like oak, pine, or birch, selected for their innate strength and aesthetic allure.

Crafted by skilled artisans using traditional techniques such as dovetail and mortise-and-tenon joinery, barn doors exhibit meticulous attention to detail and a commitment to precision.

Their structural design, characterized by unique X-shaped crossbeams and vertical wooden boards, enhances both stability and rustic charm.



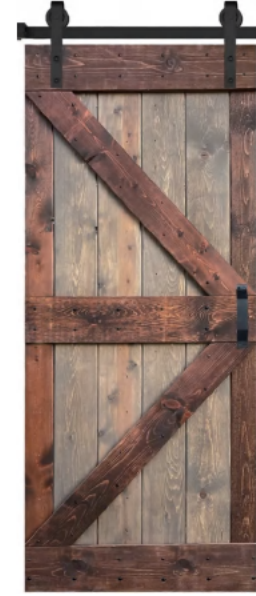

Width	18"	20"	24"	28"	30"	32"	34"	36"
Height	78"	80"	84"	88"	90"	92"	94"	96"





FOLDING DOOR



Effortless Space Enhancement with Folding Doors

Our product range includes two types of folding door systems: the pre-assembled set and the innovative self-assembly kit system. These systems seamlessly transform your living spaces, enabling you to optimize room functionality. When paired with an LPD Folding Door, your home's potential is limitless.

Folding doors are cleverly designed to make the most of underutilized areas often occupied by traditional swinging doors. This makes folding door systems a stylish and modern solution, particularly in compact spaces like living rooms, en-suites, or home offices. In fact, they are adaptable enough to be used wherever you wish to maximize room space without the intrusion of a traditional door.



Width	18"	20"	24"	28"	30"	32"
Height	78"	80"	84"	88"	90"	92"



POCKET DOORS

Effortless Space Optimization with Pocket Doors

Our range offers two internal pocket door systems: the pre-assembled set and the innovative self-assembly kit system. These systems seamlessly conceal doors within your walls, allowing you to maximize your room's space. When combined with an LPD Door, the possibilities for enhancing your home are endless.

Pocket doors are ingeniously designed to reclaim often-unused space consumed by traditional swinging doors. This makes pocket door systems a sleek and contemporary solution, especially in areas where space is limited, such as living rooms, en-suites, or office spaces. In fact, they are versatile enough to be used anywhere you want to avoid a door encroaching into the room.



PRE-ASSEMBLED SET

The pre-assembled pocket door sets embody convenience, style, and ultra-modernity. These sets can be fully installed within just 15 minutes, offering unparalleled ease of use. Designed for partition walls, they are particularly well-suited for large-scale construction projects, making them a versatile choice for modern construction endeavors.

AVAILABLE FOR SINGLE OR DOUBLE DOORS

Time Saving Pre-assembled Pocket

Space Saving

Simple Installation

Suits doors 35 or 40mm thick dependant on set purchased

Max door weight 120kg per leaf

Endpost, crosspieces, cassette edge covers.

door brushes and seals supplied as standard

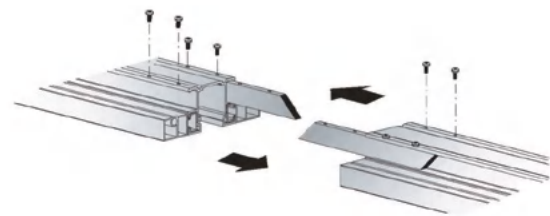

EASY 5 STEP INSTALLATION PROCESS

1. Insert aluminium track
2. Attach jamb and space bars
3. Fix to studwork
4. Apply plasterboard and plaster
5. Insert door



SELF-ASSEMBLY KIT

Great for smaller projects, this pocket door kit is easy to assemble and typically takes around 30 minutes to install. This contemporary pocket door kit can be combined with the majority of our door range and is the perfect space saving solution!

Space Saving

Self-assembly kit

Suits doors 35 or 40mm thick dependant on set purchased

Max door weight 120kg per leaf

125mm finished wall

The double kit pocket door solution is created from two singles kits joined together using the junction tongue supplied with each single kit. A double door timber pack is supplied which has a longer crosspiece.

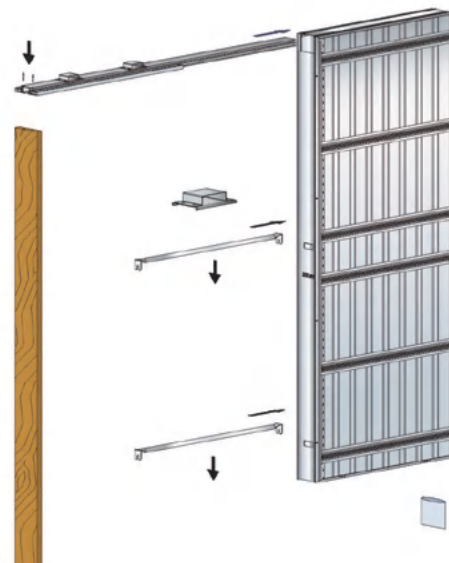



EXTERIOR DOOR



WPC DOOR

Discover the Versatility of Our WPC Door Collection

Our WPC Door Collection is ideal for modern, contemporary, and rustic settings. Each door is crafted with meticulous attention to detail, ensuring superior quality. Choose from panel or flat panel shaker designs to match your preferred style. Explore the endless possibilities that our WPC Door Collection offers today.

FIBERGLASS DOOR

Experience Excellence with Our Fiberglass Door Collection

Our Fiberglass Door Collection is the epitome of excellence, suitable for various contemporary, modern, and classic settings. Each door is meticulously crafted to deliver top-notch quality. Whether you prefer panel or flat panel shaker designs, our collection has something to suit your style. Explore the exceptional options within our Fiberglass Door Collection today.





97 E5

WPC DOOR

WOOD-PLASTIC COMPOSITE DOOR

WATERPROOF | ANTI-TERMITES | ETERNAL

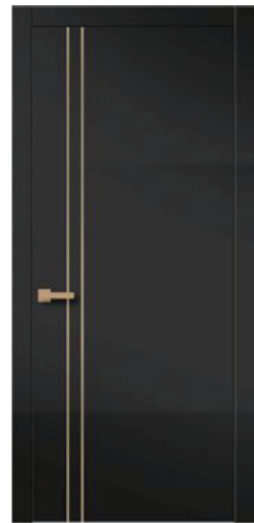
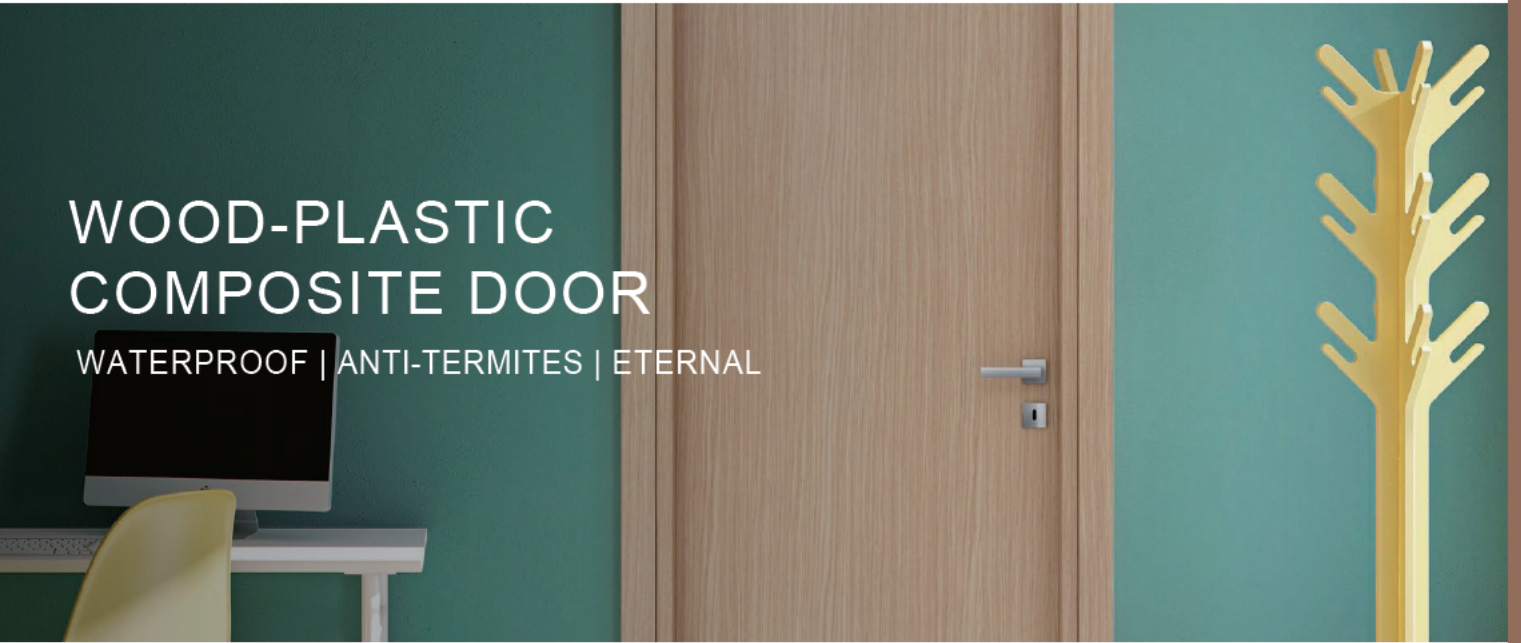

Width	18"	20"	24"	28"	30"	32"	34"	36"
Height	78"	80"	84"	88"	90"	92"	94"	96"



FIBERGLASS DOORS

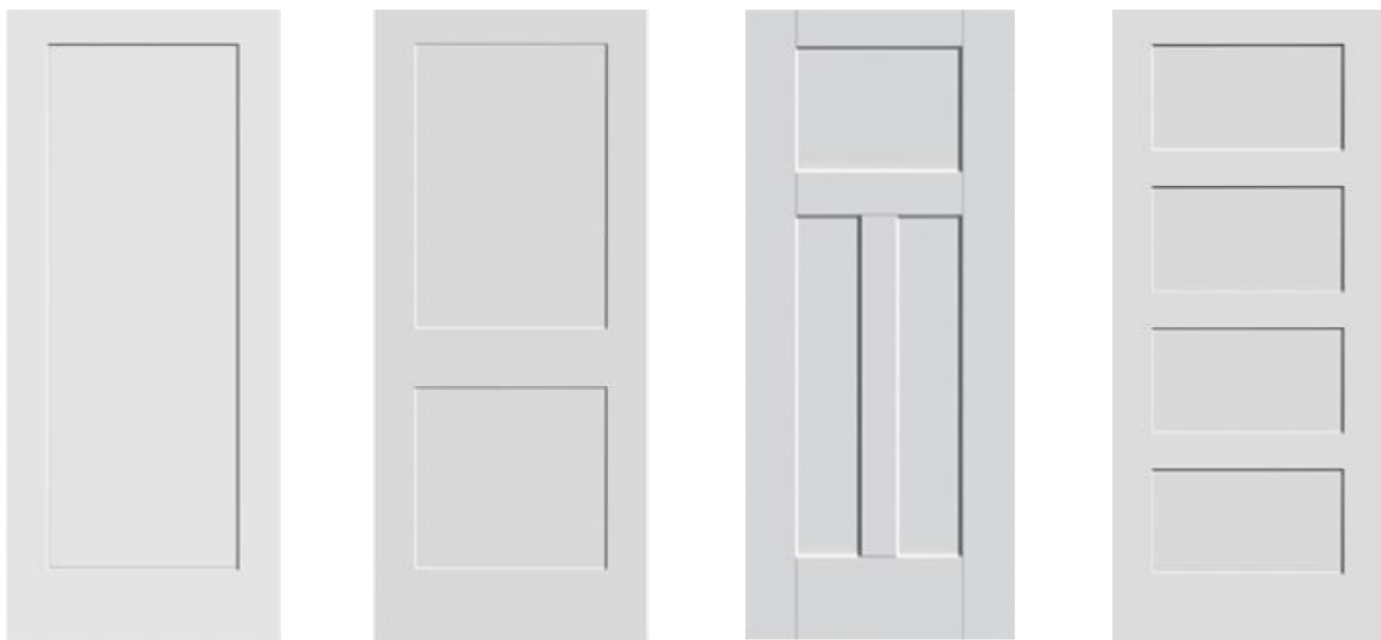

Unmatched Durability

Fiberglass doors are renowned for their strength and durability, resisting dents, warping, and rot. They are built to withstand various weather conditions, making them suitable for both interior and exterior use. With minimal maintenance required, these doors offer long-lasting reliability.

Aesthetic Versatility

Fiberglass doors come in a range of styles, finishes, and designs. They can emulate the appearance of wood, providing the classic charm of wooden doors without the maintenance hassles. Additionally, fiberglass doors offer energy efficiency, security features, and customization options to enhance your home's appeal and comfort.



ACCESSORY COLLECTION

OPTIONALS

OPTIONNELS



Handle

Door handles combine practicality with aesthetics, offering a comfortable grip, diverse style options, durability, and customization possibilities.



Hinge

Hinges enable smooth door operation, structural support, and versatility in accommodating various door types and weights.



Lock Core

Lock cores come in various types, including traditional key-operated locks and modern electronic locks, providing flexibility to meet different security needs.

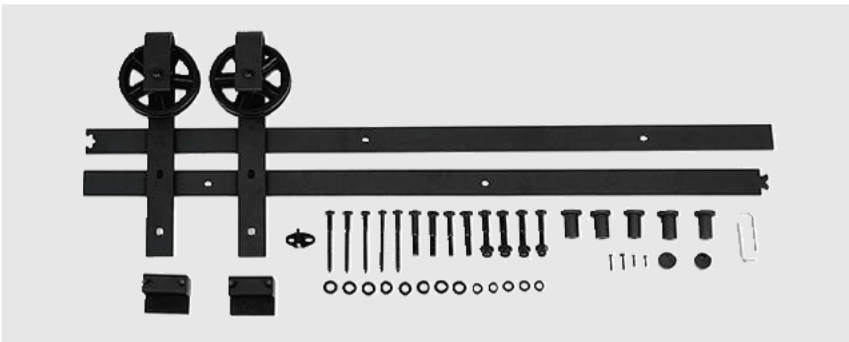

Barn Door Hardware Kit

Barn door hardware offers a blend of durability, aesthetics, and convenience, with its robust construction, diverse design options, and easy installation. It not only enhances the visual appeal of barn doors but also saves space by eliminating the need for swinging clearance.

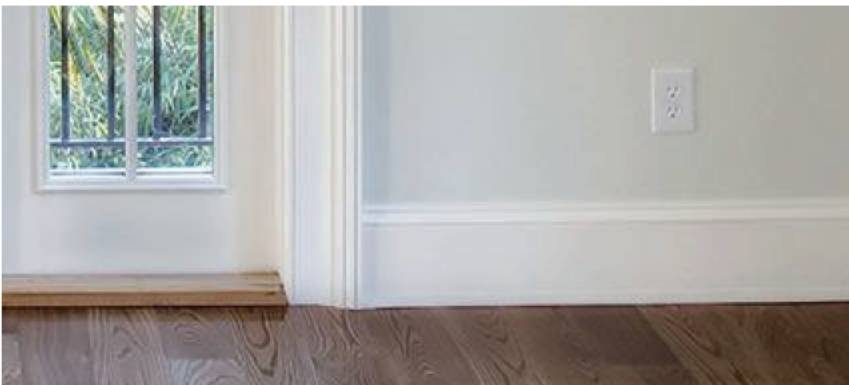

Baseboard

Baseboard is a type of molding or trim installed at the bottom of interior walls, serving both decorative and protective functions by adding a finishing touch to the room's decor and safeguarding the wall from damage.

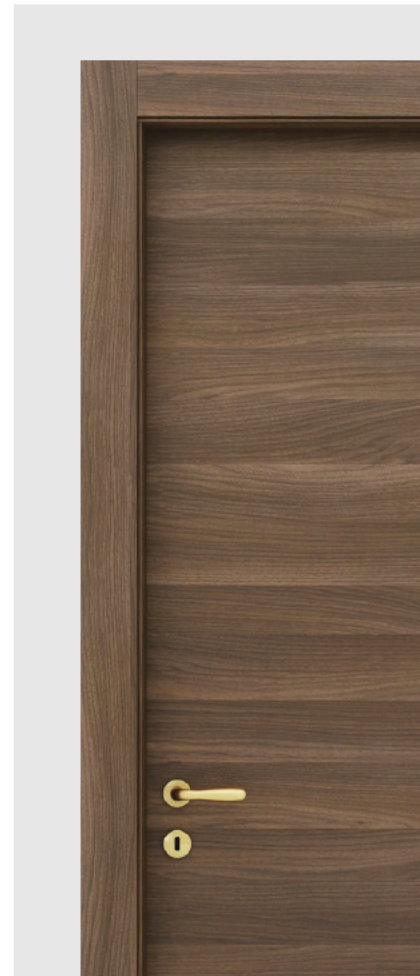

Door Frame

Door frames enhance room aesthetics, protect walls and allow customization to match interior decor.



KWIKSET

Halifax Square Matte Black Bed/Bath DoorLever with Lock (4-Pack)



KWIKSET

Casey Matte Black Bed/Bath Privacy DoorHandle Featuring Microban with Lock



KWIKSET

Hollis Round Rose Matte Black PrivacyBed/Bath Door Lever



SCHLAGE

Accent Aged Bronze Privacy Bed/BathDoor Handle



KWIKSET

Halifax Square Satin Nickel Privacy Bed/Bath Door Lever with Lock (4-Pack)



SCHLAGE

Accent Satin Nickel Classic Keyed EntryDoor Handle



INTERNAL HINGES



SATIN STAINLESS STEEL 3" HINGE

Hinge 4 x 3in x 3mm 2BB
(Pack of 3)



POLISHED STAINLESS STEEL 4" HINGE

Hinge 4 x 3in x 3mm 2BB
(Pack of 3)



MATT BLACK 4" HINGE

Hinge 4 x 3in x 3mm 2BB
(Pack of 3)



SATIN CHROME CONCEALED HINGE

Hinge 130
(Pack of 2)



MATT BLACK CONCEALED HINGE

Hinge 130h x 30w mm
(Pack of 2)

Functional Door Accessories



“SIMPLISTIC, VERSATILE AND CONTEMPORARY CREATE THE PERFECT FINISH”



WPC Door Jamb



Pine Wood Door Jamb



Door Crossheads

CLASSIC CROSSHEAD



ASHFORD CROSSHEAD



CRAFTSMAN CROSSHEAD



PANEL CROSSHEAD



STANNIS CROSSHEAD



CRAFTSMAN CROSSHEAD



BASEBOARD & DOOR FRAME

CLASSICAL | TRADITIONAL | MODERN



“

The combination of baseboard and door frame, protecting the walls from wear and tear while adding aesthetic appeal to the room, is truly the finishing touch!

”



Sales Line: 858-999-9081

Email: INFO@BUILDERSOLUTIONUS.COM